

ELAD FDM-DUO

Dual Mode SDR Transceiver



USER MANUAL

Contents

Revision History	4
1 Overview	5
1.1 Notice	5
1.2 Firmware versions.....	5
1.3 Introduction	5
1.3.1 Main Features	5
1.3.2 General Block Diagram.....	6
1.3.3 Input and Output Stages Block Diagram.....	6
1.4 Precautions	7
2 Panels Description.....	8
2.1 Front Panel Description	8
2.2 Rear Panel Description.....	9
3 LCD Display.....	13
4 Quick Start.....	15
4.1 First of all.....	15
4.2 Reset	16
4.3 A first trip	16
4.3.1 Reception	16
4.3.2 Transmission	19
5 User Interface	21
5.1 VFO Mode	21
5.1.1 Receive	21
5.1.2 Transmit	24
5.2 Split Functionality	26
5.3 MEM Mode	27
5.3.1 Select and edit a memory	27
5.3.2 Delete a memory.....	27
5.3.3 Set memory to VFO.....	27
5.3.4 Change the memory display mode	28
5.4 Antenna Tuning Mode	28
5.5 Maximum settable frequency.....	29
5.6 Knobs functions.....	29
5.7 Keys functions	31

5.8	Microphone Keys functions	31
5.9	Settings Menus List	32
5.9.1	Frequency visualization offset menu	37
5.10	Transmission source.....	38
6	CAT Remote Control	39
6.1	General Specifications.....	39
6.2	Commands Types	39
6.3	Cat Commands	40
6.3.1	Commands list.....	40
6.3.2	Commands tables.....	42
6.3.3	Compatibility commands	67
7	Software & Driver Installation	73
7.1	Software installation	73
7.1.1	First-time install in Windows 8 and Windows 7	73
7.1.2	First-time install in Windows XP	78
7.1.3	Update an existing software version	82
7.2	USB driver	83
7.2.1	USB driver installation in Windows 8 and Windows 7.....	83
7.2.2	USB driver installation in Windows XP.....	90
7.2.3	USB sound card	97
7.2.4	USB CAT Serial port	98
8	Firmware update.....	99
9	Technical Specifications	100
	Product Warranty	101
	Declaration of Conformity (EC).....	102
	Declaration of Conformity (FCC).....	103

Revision History

Revision	Date	Description
Rev 2.2	04/2016	<ul style="list-style-type: none"> Added the OW cat command description. Added the PD (PTT DELAY) cat command description. Updated the MA, MB and RF cat command descriptions with CWR information. Added to the settings menu list the description of the PTT DELAY menu, number 57. Added the transmission source section for AM, FM and SSB modes (see 5.10 - Transmission source). Updated firmware versions table.
Rev 2.3	06/2016	<ul style="list-style-type: none"> Updated the picture in the section 5.1.1.2 - E1 Receiver Settings with the AGC Threshold parameter. Updated the section 5.2 - Split Functionality. Added to the 5.9 - Settings Menus List section the description of the PTT ON CW menu, number 58. Added the TC (PTT ACTION FOR CW) and SP (SPLIT) cat command descriptions. Updated the section 8.4 - User interface (UI) firmware update. Updated the firmware versions table.
Rev 2.4	11/2017	<ul style="list-style-type: none"> Added Product Warranty
Rev 2.5	11/2017	<ul style="list-style-type: none"> Added the CD (CW Delay), TH (AGC Threshold), FF (FX FUNCTIONS) and TR (PTT with RTS) cat command descriptions. Moved Firmware Update section in another document. Updated the firmware versions table.
Rev 2.6	12/2017	<ul style="list-style-type: none"> Added the FM MODE menu description, see 5.1.1.8 - Change Operating Mode and 5.9 - Settings Menus List. Updated firmware versions table.
Rev 2.7	05/2018	<ul style="list-style-type: none"> Added the CP (CW PARTIAL MESSAGE), CS (CW SPEEDS), TQ (TRANSMISSION POWER FINE LEVEL) and VE (VFOs EQUAL) cat command descriptions. Updated firmware versions table.
Rev 2.8	06/2018	<ul style="list-style-type: none"> Updated the description of the setting menu 34 "TX POWER". Updated the VM and TQ cat command descriptions. Updated firmware versions table.
Rev 2.9	02/2019	<ul style="list-style-type: none"> Reviewed section 5.9 - Settings Menus List. Added section 1.3.3 - Input and Output Stages Block Diagram. Added cat commands descriptions; BH, BP, BR, CK, DE, DF, ET, FM, HT, IA, KT, QS, RN, SA, SI, TV, UD, UU and WT. Updated firmware versions table.
Rev 2.10	02/2019	<ul style="list-style-type: none"> Updated CI cat command description.

1 Overview

1.1 Notice

Amateur radio regulations vary from country to country. Check your local amateur radio regulations and requirements before operating the ELAD FDM-DUO.

1.2 Firmware versions

The features described in this manual refers to the following firmware versions :

RX Demodulator	TX Modulator	User Interface	USB Interface	FPGA
Ver. 1.50 Date: 03/13/2018	Ver. 1.35 Date: 01/14/2019	Ver. 4.87 Date: 02/06/2019	Ver. 4.09 Date: 05/28/2015	Ver. 2.00 Date: 07/30/2014

1.3 Introduction

Thank you for choosing the FDM-DUO. It is an innovative dual mode SDR (Software Defined Radio) transceiver covering the frequency range from 9kHz to 54MHz. The FDM-DUO can be used like a standard transceiver in stand-alone mode or in remote mode to exploit the full potential of the ELAD FDM-SW2 software. The FDM-DUO can still be connected to the FDM-SW2 software when it works in "stand-alone" mode.

NOTE: For detailed information about ELAD FDM-SW2 software refer to user manual available at http://sdr.eladit.com/FDM-sw2_20Software/Doc/

1.3.1 Main Features

- Reception frequency range: 9kHz to 54MHz in direct sampling mode.
- Transmission bands: 160m to 6m.
- Selectable output power of 5W or 0dBm RF Out connector.
- Double antenna connectors (RTX for single antenna use or RX/TX for separated antenna use).
- Operating modes: CW, CWR, LSB, USB, AM and FM.
- ADC Linear LTC2165, 16bit @122.88MHz.
- FPGA Spartan 6 XC6SLX25 + Serial Flash for stand-alone mode.
- Stand-alone RX demodulator with STM32F4 ARM floating point μ Controller.
- LPC1766 Cortex M3 for LCD & Keyboard control.
- TX modulator with STM32F4 floating point μ P + AD9957 DDS @368.64 MHz.
- Clocking source Si5338 driven by 10MHz TCXO or external reference input.
- TX modulator from I2S source: MIC using Cirrus CS5346 or USB integrated Codec (CM6510B codec with customized firmware).
- CAT USB interface with FTDI controller.

1.3.2 General Block Diagram

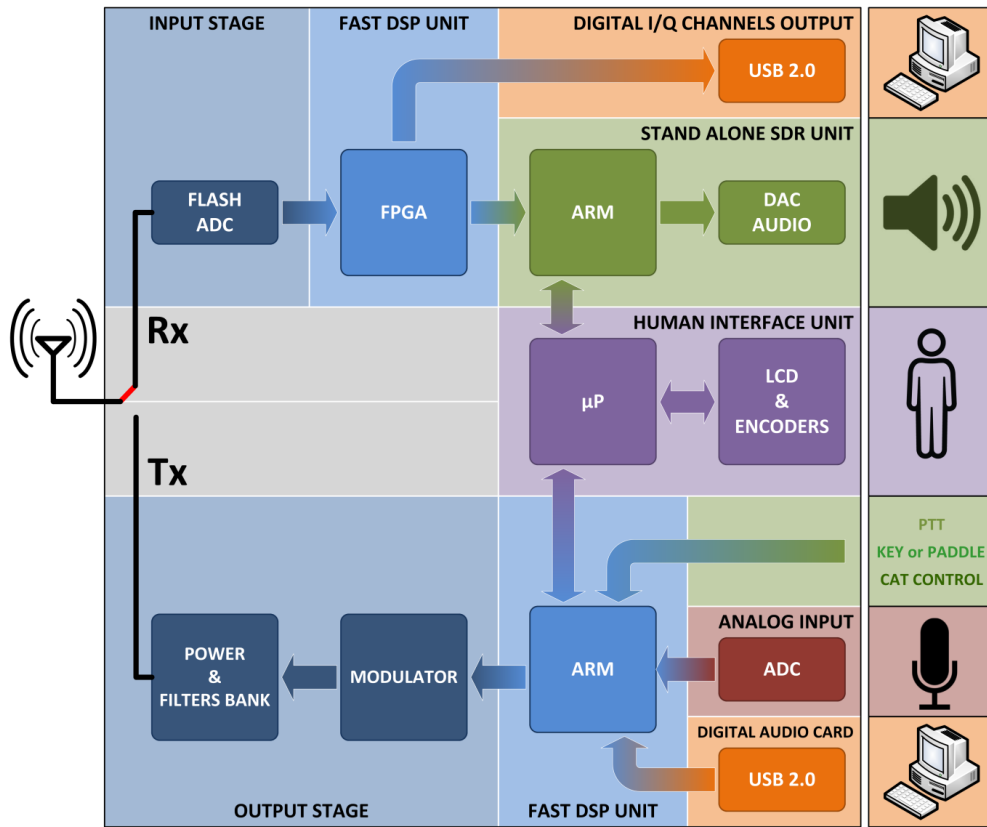

1.3.3 Input and Output Stages Block Diagram

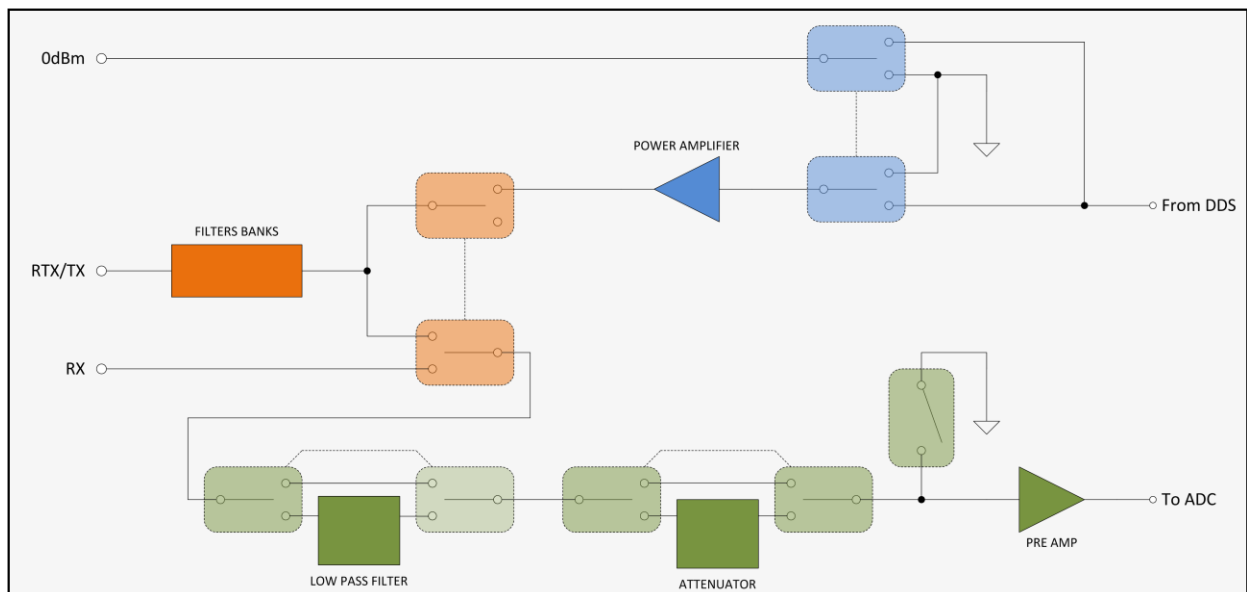

1.4 Precautions

- Connect the transceiver only to a power source described in this manual.
- Take care when plugging-in cables, avoid applying sideways pressure that might damage the connectors.
- Avoid operating in wet conditions.
- For better performance and safety, connect the transceiver to good earth ground using a short, heavy, braided cable.
- Ground all outdoor antennas for this receiver using approved methods. Grounding helps protect against voltage surges caused by lightning. It also reduces the chance of build-up of static charge.

2 Panels Description

2.1 Front Panel Description



1 - LCD Display

See [LCD Display](#).

2 - E1 Knob

Available functions : settings of audio volume, squelch for FM, microphone gain (MIC) while transmitting, reception gain control (AGC), noise reduction (NR), noise blanker (NB) and auto notch (AN). See [Knobs functions](#) for more information about knobs use.

3 - Main Knob

Available functions : VFO tuning, memory selection in MEM mode, step selection in VFO mode. See [Knobs functions](#) for more information about knobs use.

4 - Main audio output for speakers and headphones

5 - Auxiliary audio output

6 - E2 Knob

Available functions : settings of reception filters, transmission power (PWR) while transmitting, CW pitch value, and RIT value. See [Knobs functions](#) for more information about knobs use.

7 - MODE and MENU buttons

Operating mode selection (AM, CW, ...). Tune mode activation. "QuickStep" function activation. Access to the setup menu. See [Keys functions](#) for more information about keys use.

8 - VFO and MEM buttons

Basic VFO and memory operations. See [Keys functions](#) for more information about keys use.

2.2 Rear Panel Description

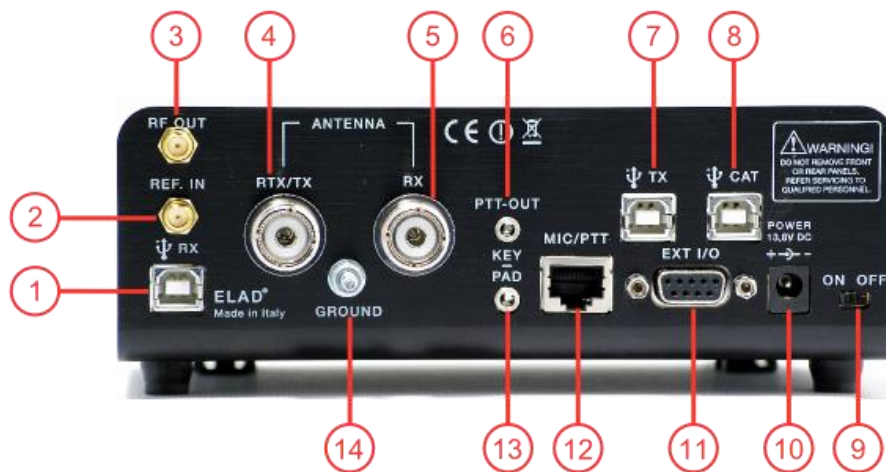

1 - USB Receiver Data Connector

USB 2.0 port. Connect it to computer to use the SW2 software. Please use the supplied cable.

2 - Frequency Reference Input

SMA 50 Ohm connector. Apply an 10MHz 0dBm signal.

3 - RF Output Connector

SMA 50 Ohm connector. 0dBm transmission signal.

4 - Output/Input Antenna Connector

M-type 50 Ohm connector. Antenna output when using two antenna (TX). Antenna input when using only one antenna (RTX).

5 - Input Antenna Connector

M-type 50 Ohm connector. Antenna input when using two antenna (RX).

6 - PTT Output Connector

3.5mm stereo jack connector. PTT Output to connect a switch-box or an amplifier. This output is enabled while transmitting.



RING: do not connect (reserved for future use)

TIP: PTT output (NPN Open Collector transistor, max.: 20V/200 mA)

7 - USB Audio Connector

USB 2.0 port. Connect it to the computer to access to the FDM-DUO soundcard. In input, allows fully digital transmissions. In output, allows to access to the received signal in a digital way.

8 - CAT USB Serial Port

USB 2.0 port. Connect it to the computer to manage the FDM-DUO through the CAT (Computer Aided Transceiver) protocol.

9 - Power Switch

Turn on /off the FDM-DUO.

10 - Power Connector

Voltage to apply : 13.8V. Maximum current consumption : 2.5A DC.

11 - Expansion Port

DB9 connector for external hardware. **THIS IS NOT A STANDARD SERIAL PORT.**

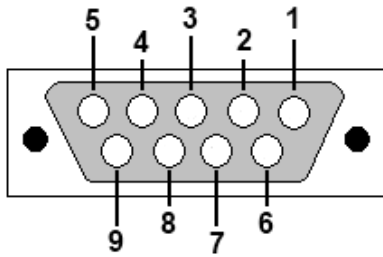

- Pin 1: SPI Latch
- Pin 2: I2C SCL
- Pin 3: SPI Clock
- Pin 4: I2C SDA
- Pin 5: Ground
- Pin 6: TX Duo
- Pin 7: RX Duo
- Pin 8: SPI Data
- Pin 9: +5V

12 – Microphone Connector

Microphone connector with PTT command. Please use the supplied one. The following image show the connector pinout watching the FDM-DUO rear panel.

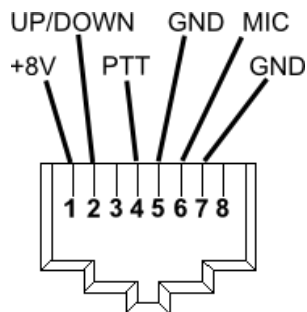

13 – Key/Paddle connector

3.5mm stereo jack connector.



The menu 37 (CW IN) allows to choose the input type (key or paddle).

The menu 39 (CW KEY) lets you choose the type of connection made when you use a key (i.e., connection on the TIP or on the RING).

The menu 40 (CW TIP) lets you choose the type of connection made when using a paddle (i.e., position of the dot and the dash on the TIP or on the RING).

14 – Ground Connector

For better performance and safety, connect it to an earth ground using a short and wide cable.

3 LCD Display

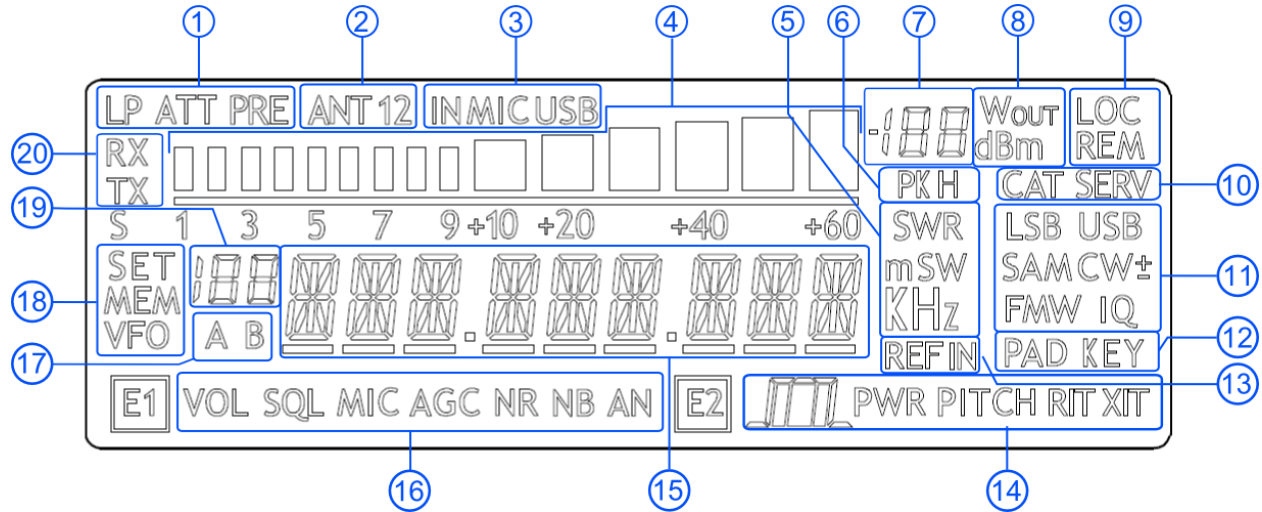

1. LP: turns on when the low pass filter is active.
ATT: turns on when the attenuator is active.
2. ANT 1 2: displays the number of antennas chosen.
3. IN MIC USB: displays the input selected for transmission in SSB, AM and FM modes. Microphone or USB TX connector.
4. METER: while receiving displays the signal strength in S-units, in transmission displays the output power.
5. Units of measurements of the values displayed. The “S” letter of SWR is also used to indicate that the “QuickStep” function is active.
6. PK: blinks if the ADC of reception is “overloaded”.
7. Secondary indication: while receiving displays the signal strength in dBm, in transmission displays the output power in watt.
8. Measurement unit for the secondary indication.
9. LOC: turns on when the Main Knob is locked.
REM: turns on when the remote mode is active, turns off when the stand-alone mode is active.
10. CAT: turns on when a CAT command is received.
SERV: turns on when the service mode is enabled.
11. Operating mode.
12. Input selection for CW mode.
13. Turns on when the external frequency reference is present.
14. E2 selected function.
 - : reception filter setting.
 - PWR: transmission power setting (while transmitting).
 - PITCH: CW pitch frequency setting.
 - RIT: RIT setting.
15. Alphanumeric characters to displaying messages and numeric values.

16. E1 selected function.
 - VOL: main volume setting,
 - SQL: squelch setting (for FM mode),
 - MIC: microphone gain (while transmitting),
 - AGC: automatic gain control settings,
 - NR: noise reduction setting,
 - NB: noise blanker setting,
 - AN: auto notch setting.
17. Displays the selected VFO, A or B.
18. MEM: turns on in memory mode.
 - VFO: turns on in VFO mode.
 - SET: turns on when the setting menu is shown.
 - SET: turns on jointly to MEM when the VFO→MEM menu is active.
19. In memory mode, displays the selected memory index.
 - When in the setting menu, displays the menu number.
 - In split, displays "SP".
20. RX: turns on when receiving.
 - TX: turns on when transmitting.

4 Quick Start

These instructions are intended only for a quick guide, detailed instructions are given later in this manual.

4.1 First of all

To avoid having a forest of buttons and knobs as front panel, each control has different operating modes.

The buttons can be “short pressed” or “long pressed” to activate different functions. The different functions associated to each pressure are written in different colors just above the corresponding button. Each top white label is associated to the “short pressure” on the button, while the lower blue label is associated to the “long pressure”.

Example

A/B
M

swaps A and B VFOs if “short pressed”, and swaps VFO and Memory mode if “long pressed”.
The A/B label refers to the A/B VFO swap obtained with a “short pressure”.
The M label refers to the VFO/Memory mode swap obtained with a “long pressure”.

Long Pressure

A button is “long pressed” when it is kept pressed for more than 1 sec.
This value can be changed using menu 71 (Hold Time) as explained in section 5.9 - Settings Menu List.
Valid values can vary from 500 ms to 2500 ms.

The knobs can be pressed as well to control a different parameter.

Example

The E1 knob usually controls the audio volume, but if pressed once it controls the squelch value.

Tuning

The tuning knob can be pressed to change the tuning step or to enter the “Digit by digit tuning mode”.
The tuning knob operations are detailed in section 5.1.1.1 - Tuning.

4.2 Reset

When first approaching a largely programmable device like FDM-DUO it is nearly unavoidable to mess some parameters with useless values. This is not a problem and should not prevent users from trying the different settings, since a “reset” command is available to bring back the device to the factory settings.

Reset

The reset procedure is quite simple:

- short press the MENU button
- turn the F2 knob until reading 81 DEFAULT on the display
- short press the E2 knob to show “N” on the right of DEFAULT
- turn the E2 knob to change “N” to “Y”
- short press the E2 knob
- wait for the radio reset and restart

4.3 A first trip

A radio like FDM-DUO has many possible application scenarios, both used as a stand-alone device, and paired with its mate software.

In this section the simplest and most common uses will be shown, to allow a first familiarization with FDM-DUO.

4.3.1 Reception

The first use for FDM-DUO is, clearly, reception. To do that, just connect the device to a 12V power supply (or to a battery) and turn it on by using the back switch.

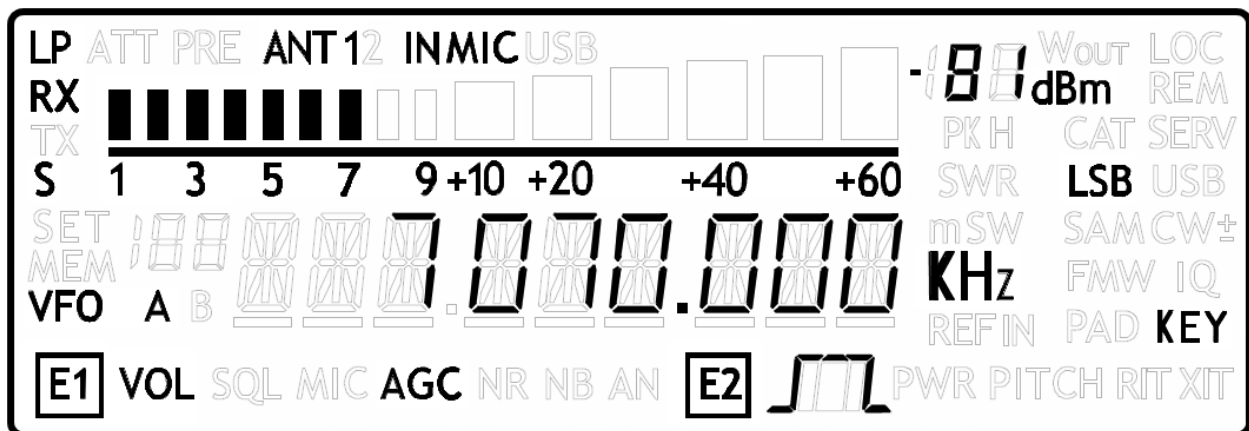

After some secs the device is in reception mode with VFO A enabled.

The main controls are as follows:

Bands

FDM-DUO does not have the “band” concept, thus there is no “band switch”.

There are, though, some special memories holding the value of the low frequency limit of each band as factory settings.

The “Quick Mem” mode can be used to quickly reach the wanted band; it is activated by long pressing the  button.

Press and hold the  button until the display shows the wanted band.

Modes

The  button is used to change to mode: at each short press the mode is changed to the next possible mode.

Tuning

The tuning is done using the main tuning knob.

It is possible to change the tuning step to an alternate value with a short pressure on the  button.

Another short pressure on the  button resets the usual tuning step.

It is possible to change the tuning step to various values with a short pressure on the tuning knob. This leads the tuning knob to select different tuning steps.

Once the desired step has been selected, another short pressure on the tuning knob will bring it back to control the tuning, using the new selected step.

Volume and bandwidth

The volume is set by the E1 knob.

The E2 knob controls the bandwidth.

Enhancing Reception

By clicking on the E1 knob, it is possible to activate some useful options:

1. Audio Volume: this, as seen previously, is the default behavior;
2. Squelch Value: if activated, the related icon on the display blinks;
3. Automatic Gain Control On/Off: if activated, the AGC icon on the display blinks;
4. Automatic Gain Control Speed: it is possible to select Slow, Medium, or Fast;
5. Noise Reduction: it is possible to activate and set the level, if activated the NR icon on the display blinks;
6. Noise Blanker: it is possible to activate and set the level, if activated the NB icon on the display blinks;
7. Auto Notch: it is possible to activate and select two different levels of intervention; when activated, Auto Notch detects and kills an audio persistent tone.

By clicking on the E2 knob, it is possible to activate some useful options:

1. Filter Bandwidth: this, as seen previously, is the default behavior;
2. CW Pitch: this allows to choose the preferred CW reception tone;
3. Receive Incremental Tuning On/Off;
4. Receive Incremental Tuning Value: this allows to move the reception frequency away from the transmission frequency; this function appears only if the previous Receive Incremental Tuning is set to On. More information can be found in section 5.1.1.3 - E2 Receiver Settings.

4.3.2 Transmission

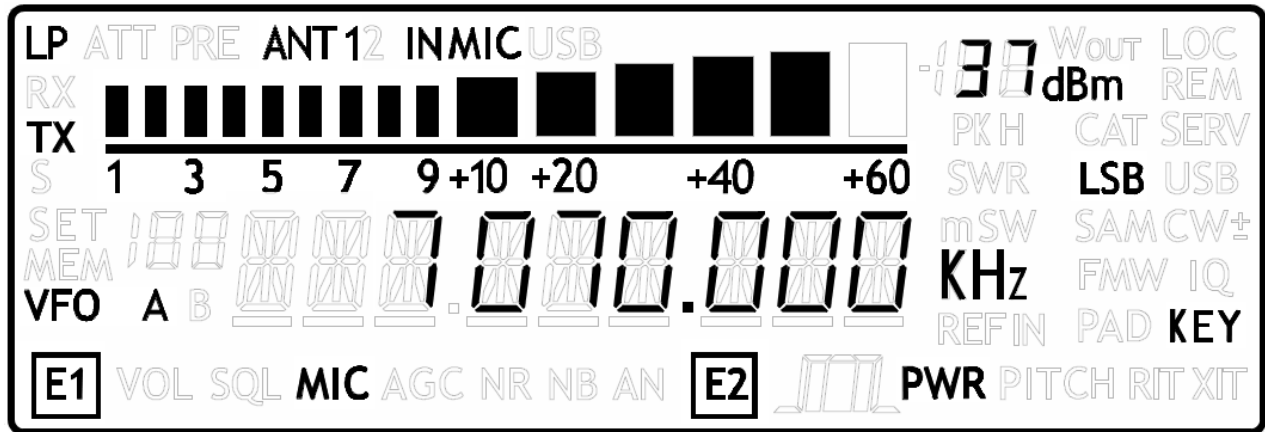

Before transmitting, always check the antenna conditions, so as to avoid problems to the PA; this must be done on a free frequency to avoid disturbing any running QSOs.

Transmission

When FDM-DUO is transmitting, the display changes its backlight.

Using the parameter 73 – “BACKLIGHT CHANGING” it is possible to disable this change if it is deemed annoying, for example when operating in CW Break In mode.

Transmission in AM, SSB and FM Mode

To transmit you just have to use the PTT on the mike and speak.

In case of need it is possible to use the E1 knob to control the “Mic Gain”: a short pressure on the E1 knob lets you control the Mic Gain instead of Volume, and vice versa.

Transmission in CW

Transmission is driven by the CW key.

The E1 knob controls the Volume or the CW speed (in WPM). The two functions can be swapped with a short press on the E1 knob.

Antenna Tuning

Due to the importance of the antenna tuning, FDM-DUO is capable to generate the signal that allows antenna tuning.

This can be done with a long pressure on the  button.

The transmission will end after a time period established by parameter 49 - "TUNE TIME" (factory set to 10 secs) or by a new long pressure on  button.

During the transmission it is possible to show different information: pressing E2 knob it is possible to show frequency or forward power, or reflected power, or Standing Wave Ratio.

During the transmission it is possible to tune the antenna, if needed using an external ATU.

The tuning operations could be refined using parameters 55 – "TUNE POWER" and 56 – "TUNE PTT".

Parameter 55 – "TUNE POWER" allows to select the power to be used when in tune mode, for example reducing the power as a means to protect final power transistors when not sure of the antenna conditions.

Parameter 56 – "TUNE PTT" allows to deactivate an external PA during tuning operations, by disabling the PTT Out signal during tuning operations.

5 User Interface

5.1 VFO Mode

5.1.1 Receive

The VFO mode is the default mode of FDM-DUO. Each VFO memorize the tuning frequency, mode and tuning step

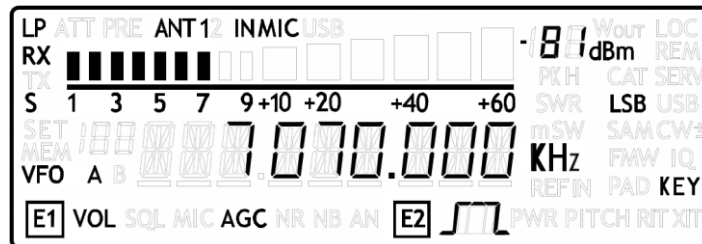

5.1.1.1 Tuning

In this mode, use the Main Knob to tune a frequency.

A short pressure on the main knob enter the frequency step menu

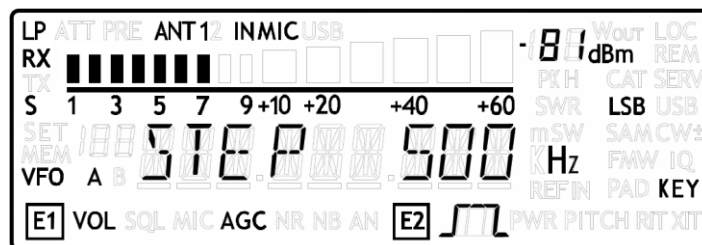

Use the main knob to modify the tuning step, then with a short pressure return in the VFO menu.

With a long pressure over the main knob, the Digit by Digit Frequency tuning mode is activated

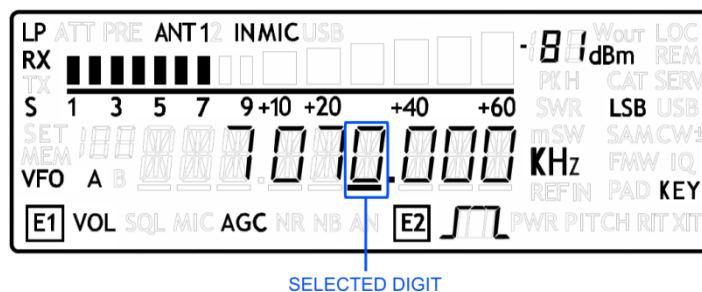

In this mode use the main knob to modify the selected digit and E1 or E2 to change witch digit you want to modify. Apply a short pressure on main knob to return in the standard tuning mode.

5.1.1.2 E1 Receiver Settings

Apply a short pressure on the E1 knob to change the E1 selected parameter, the selected parameter icon is turned on in the LCD. Turn until one click the E1 knob to display the parameter value, then turn again E1 to modify the parameter value.

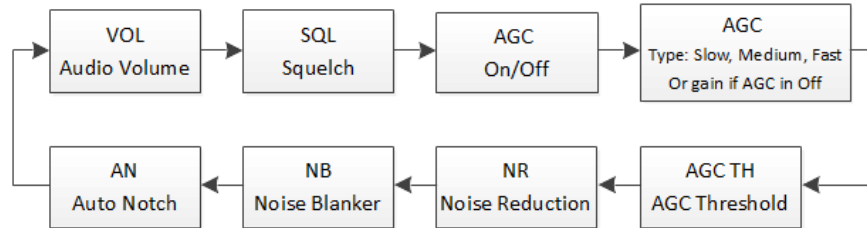

SQL: if the Squelch is turned on the relative SQL icon blinks.

AGC: if the AGC is turned OFF (manual gain mode), the AGC icon blinks.

NR and NB: if the Noise Reducer or the Noise Blanker is turned on the relative NR or NB icon blinks.

5.1.1.3 E2 Receiver Settings

Apply a short pressure on the E2 knob to change the E2 selected parameter, turn until one click the E2 knob to display the parameter value, then turn again E2 to modify the parameter value.

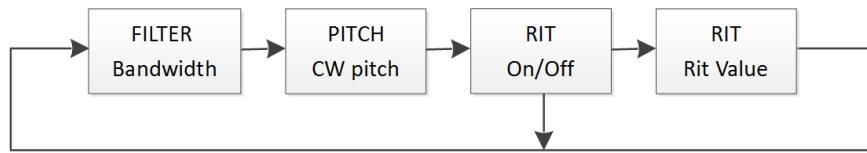

RIT: if the RIT is turned on the relative RIT icon blinks, note that if the RIT is turned off the “Rit Value” menu is not displayed. To modify the RIT value you have to use the E2 knob to change the selected digit and press the **S F4** key to change the digit selection. Keep press the **S F4** key to reset the RIT value.

5.1.1.4 Switch VFO

Use the **A/B M** button to switch VFO-A/B.

5.1.1.5 Store VFO to Memory

Use the **V-M F1** key to store the current VFO settings into a memory

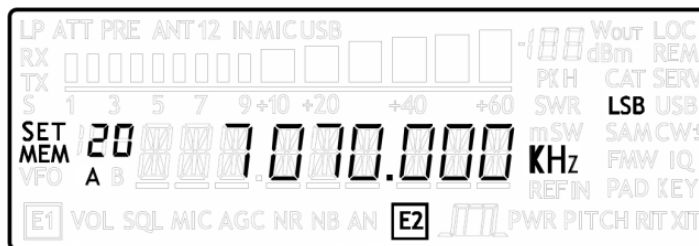

Use E2 knob or main knob to select the destination memory and confirm with a short pressure on E2.

5.1.1.6 “QuickMem” Mode

Keep pressed the **V-M F1** key to enter the “QuickMem” mode. The memory channels 180 to 199 are reserved for the “QuickMem” selection. Keep pressed the **V-M F1** key until the desired frequency appears on the LCD display, then release the key and the current VFO is set to the frequency and mode saved in the memory channel. You can use the “FDM-DUO Manager” feature in the ELAD FDM-SW2 software to customize the memory channels.

5.1.1.7 VFO-A = VFO-B

With long pressure on **M-V F2** key you get VFO-A = VFO-B

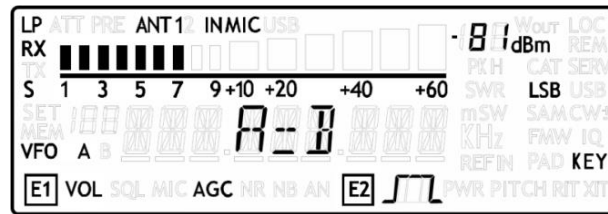

5.1.1.8 Change Operating Mode

With a short pressure on the **MODE F3** button, you can change the receiver mode between the available modes:

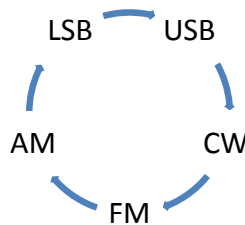

When you do not use the FM mode, you can disable it with the setting menu 14 “FM MODE”. The main purpose of this functionality is to not hear the FM exasperating noise when changing between modes and you are not using the FM mode.

5.1.1.9 “QuickStep”

With a short pressure on the **S F4** key, the “QuickStep” function is activated. This function quickly sets the frequency step preset selected in the “QuickStep” setting menu, press again the **S F4** key to set the previous frequency step.

5.1.2 Transmit

During the transmission some operations like tuning, VFO selection, mode selection are locked. With a short pressure on the E2 knob it is possible to change with parameter is shown in the main display.

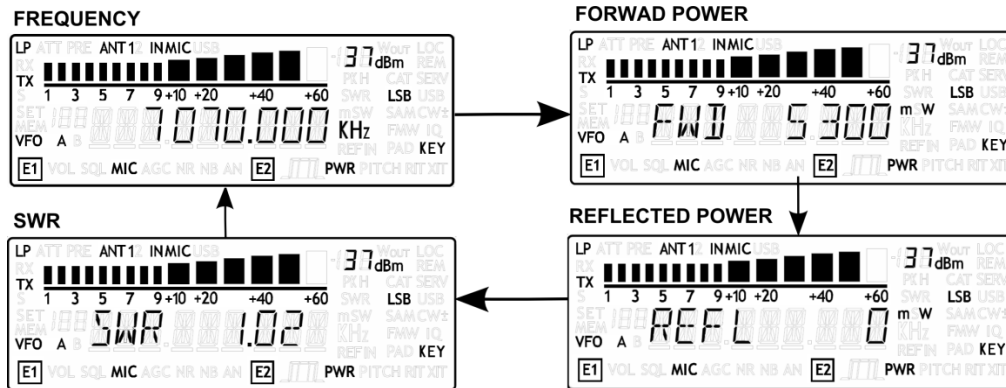

5.1.2.1 Transmission in CW Mode

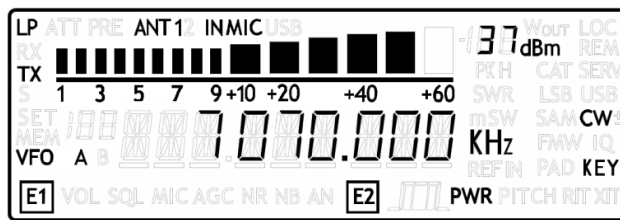

- CW Message

To begin transmit the CW message selected in the “CW message” menu (number 46), keep pressed the microphone PTT and apply a short pressure on the CW key or paddle. Push the PTT to stop the CW message transmission.

With a long pressure on **S F4** or **MENU F5** if the function has been activated in the “F4 Function” menu or in the “F5 Function” menu, the selected CW message is transmitted. Press the **S F4** or **MENU F5** to stop the CW message transmission.

- E1 transmitter settings

Turn until one click the E1 knob to display the parameter value, then turn again E1 to modify the parameter value. Apply a short pressure on the E1 knob to modify the parameter selection : “Reception Volume” or “CW Words Per Minute”.

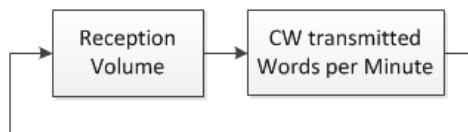

- E2 transmitter setting

Use E2 to change the transmission power.

5.1.2.2 *Transmission in AM, SSB and FM Modes*

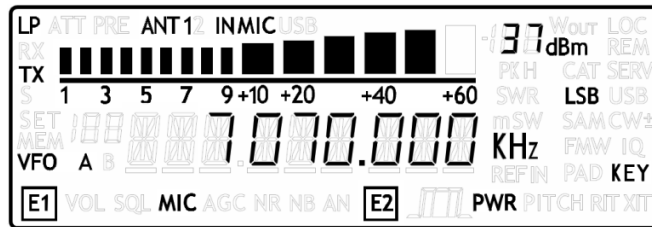

- **E1 transmitter settings**

Turn until one click the E1 knob to display the parameter value, then turn again E1 to modify the parameter value. Apply a short pressure on the E1 knob to modify the parameter selection : “Reception Volume” or “Microphone Gain”.

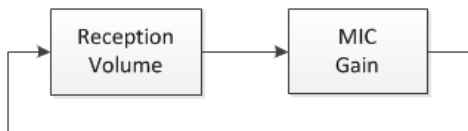

- **E2 transmitter setting**

Use E2 to change the transmission power.

5.2 Split Functionality

Usually you can communicate with other stations using a single frequency for receiving and transmitting. In this case, you select only one frequency on either VFO-A or VFO-B. However, there are cases where you must select one frequency for receiving and a different frequency for transmitting. This requires the use of 2 VFOs. This is referred to as "Split".

To activate the Split, select the "Split" option in the F4 or the F5 settings menu, then apply a long pressure on F4 or F5.

In Split the VFO-A is used to receive

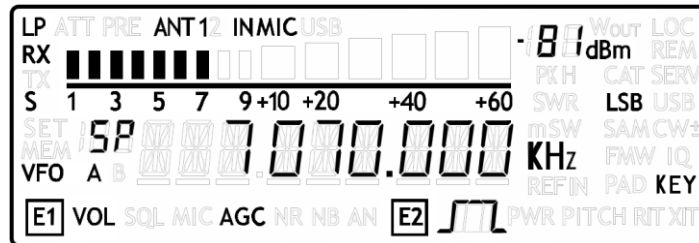

The transmission frequency is set to the VFO-B frequency

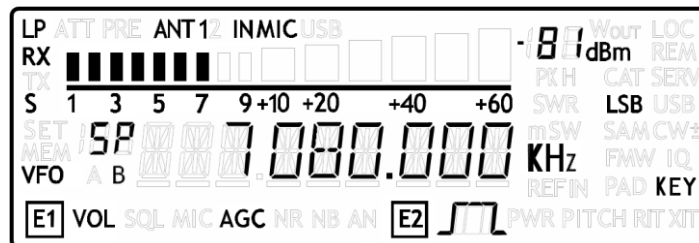

Notes :

- when the split functionality is activated the "SP" letters appear above the letter of the VFO (A or B),
- the split functionality is not available in MEM mode,
- when the split functionality is activated with the F4/F5 keys it is called stand-alone split, when the split functionality is activated by the FDM-SW2 software it is called remote split,
- when the remote split is active you can change the mode and frequency of the VFO-B only with the FDM-SW2 software, these parameters are then not settable from the FDM-DUO front panel.

5.3 MEM Mode

To activate the memory mode, apply a long pressure on **A/B M**. In MEM mode it is possible to receive, transmit and change the E1/E2 settings in the same way of the VFO mode.

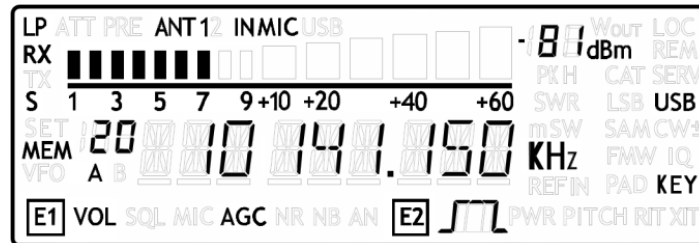

5.3.1 Select and edit a memory

Use the main knob to select a memory. Apply a long pressure on the main encoder to enter the edit memory menu. In this menu it is possible to modify the selected memory frequency in digit by digit mode.

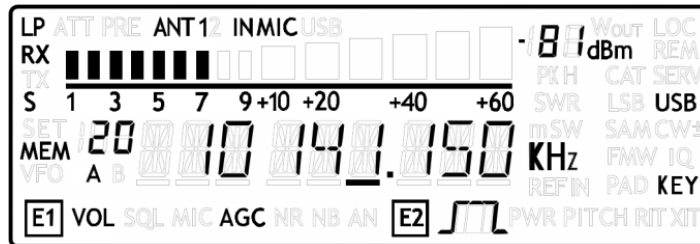

5.3.2 Delete a memory

Apply a long pressure to the **V-M F1** key to enter the delete menu.

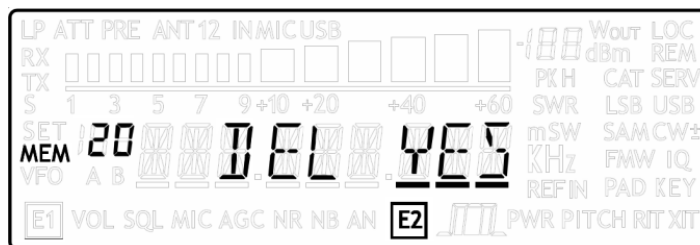

Use the E2 knob to set yes or no and make a short pressure on E2 to confirm.

5.3.3 Set memory to VFO

Use the **A/B M** button to select the VFO-A/B. Use the **M-V F2** key to set in the selected VFO the selected memory frequency and mode. When this function is used, the FDM-DUO automatically switches to the VFO mode.

5.3.4 Change the memory display mode

Apply a short pressure on the **S F4** key to show the memory label in the LCD main display. Press shortly again **S F4** to return to display the memory frequency.

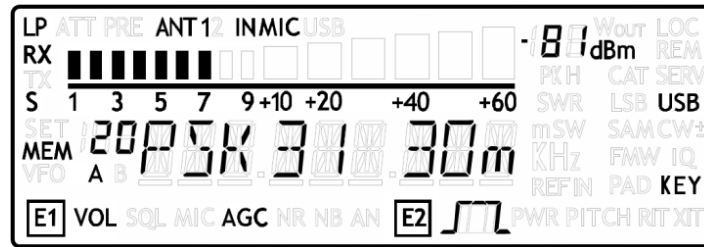

You can use the “FDM-DUO Manager” feature in the ELAD FDM-SW2 software to customize the memory channels.

5.4 Antenna Tuning Mode

In VFO or MEM mode, apply a long pressure on **MODE F3** key to switch to the Antenna Tuning Mode

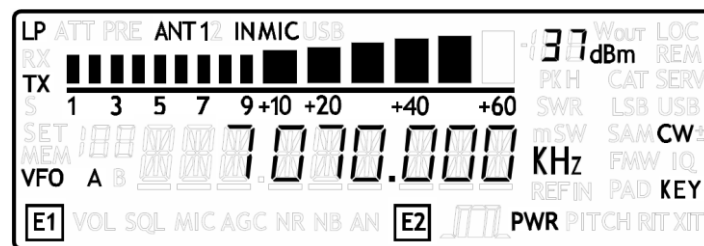

In this mode a tone at the transmission frequency is generated. Use E2 to modify the transmission power.

The antenna tuning mode have a default timeout of 10s, this value can be modified in the settings menu 49 “TUNE TIME”. However you can apply a long pressure on **MODE F3** key to exit from the antenna tuning mode.

Note:

the timeout is not active if:

- the selected transmission output is set to 0dBm,
- the “SERVICE MODE” is active.

5.5 Maximum settable frequency

The maximum settable frequency is 54MHz. However, you can unlock this limit for experimental purposes until 165MHz by setting the FDM-DUO as follows :

- low pass filter deactivated, menu 2 “RX LP” set to “OFF”,
- output in 0dBm, menu 33 “TX OUT” set to “0dBm”.

5.6 Knobs functions

The following table describes the knob functions for some user interface menu :

Menu	Action	Main Knob	E1 Knob	E2 Knob
VFO	Value modified	Change selected VFO frequency	Enter E1 selection parameter	Enter E2 selection parameter
	Short Pressure	Enter STEP menu	Change E1 selected parameter	Change E2 selected parameter
	Long Pressure	Switch to DIGIT by DIGIT tuning mode	(2)	(2)
STEP	Value modified	Change tuning step value		
	Short Pressure	Exit from STEP Menu		
	Long Pressure	Switch to DIGIT by DIGIT tuning mode	(2)	(2)
MEM	Value modified	Select next/previous memory	Enter E1 selection parameter	Enter E2 selection parameter
	Short Pressure		Change E1 selected parameter	Change E2 selected parameter
	Long Pressure	Switch to DIGIT by DIGIT tuning mode	(2)	(2)
E1 Selection: VOL - SQL - AGC - NR - NB	Value modified	Back to VFO or MEM menu	Modify E1 selected parameter value	Modify E2 selected parameter value
	Short Pressure	Back to VFO or MEM menu	Change E1 selected parameter	Change E2 selected parameter
	Long Press	Switch to DIGIT by DIGIT tuning mode	(2)	(2)
E2 Selection: FILTER - PITCH - RIT	Value modified	Back to VFO or MEM menu	Modify E1 selected parameter value	Modify E2 selected parameter value
	Short Pressure	Back to VFO or MEM menu	Change E1 selected parameter	Change E2 selected parameter
	Long Pressure	Switch to DIGIT by DIGIT tuning mode	(2)	(2)
VFO > MEM	Value modified	Change the destination memory		Change the destination memory
	Short Press			Save VFO in the selected memory
	Long Pressure		(2)	(2)

Menu	Action	Main Knob	E1 Knob	E2 Knob
Delete MEM	Value modified			Change Yes/No
	Short Pressure			Confirm Yes/No
	Long Pressure			
SETUP - PARAMETER CHOICE (MENU button)	Value modified			Change parameter selection
	Short Press			Enter parameter setup menu
	Long Pressure			
SETUP - PARAMETER MODIFICATION	Value modified	Parameter coarse variation (1)	Parameter coarse variation (1)	Parameter fine variation
	Short Press			Save and exit
	Long Pressure			
DIGIT by DIGIT Tuning	Value modified	Modify the current digit value	Change digit selection	Change digit selection
	Short Pressure	Switch to standard tuning mode	Switch to standard tuning mode	Switch to standard tuning mode
	Long Pressure		(2)	(2)

(1) Available only for certain menu.

(2) Press simultaneously E1 and E2 to lock/unlock all the keys and knobs. When the keys/knobs lock function is activated the E1/E2 icons blink.

5.7 Keys functions

The following table describes the keys functions.



Mode	Pressure	A/B M	V>M F1	M>V F2	MODE F3	S F4	MENU F5
VFO	Short	Switch VFO	Enter VFO to MEM menu	-	Change operating mode	Enable/disable Quickstep function	Enter settings menu
VFO	Long	Switch to MEM mode	Enter "QuickMem" menu	VFO A = B	Enter/Exit antenna tuning mode	F4 Selected Function	F5 Selected Function
MEM	Short	Switch VFO	-	Selected memory to VFO	Change selected memory operating mode	Change memory display frequency/label	Enter settings menu
MEM	Long	Switch to VFO mode	Enter delete memory menu	-	Enter/Exit antenna tuning mode	F4 Selected Function	F5 Selected Function

5.8 Microphone Keys functions

The following table describes the microphone keys functions.

Mode	Pressure	UP UP Keep pressed	DOWN DOWN Keep pressed
VFO	Short	Tune up frequency of one step	Tune down frequency of one step
VFO	Keep pressed	After HOLDTIME tune up the frequency according with the acceleration	After HOLDTIME tune down the frequency according with the acceleration
MEM	Short	Selected memory to VFO	Selected memory to VFO
MEM	Keep pressed	Selected memory to VFO and after HOLDTIME tune up the frequency according with the acceleration	Selected memory to VFO and after HOLDTIME tune down the frequency according with the acceleration

5.9 Settings Menus List

The following table describes the FDM-DUO settings menus list. To enter the settings menu mode, press the  key. Use E2 to select the menu, then apply a short pressure on E2 to display the current menu setting, if you want to change the setting use the E2 knob and confirm the setting with a short pressure on E2. In some menu you can also use the main knob to change the setting more quickly. To turn back or exit the menu just press .

Menu	Title	Description	Available Settings	Default	Main Knob Use	Relative CAT Command
RECEPTION MENUS						
1	RX ATT	Receiver input attenuation.	OFF or ON	OFF	-	AT
2	RX LP	Receiver low pass filter status.	OFF or ON	ON	-	LP
3	SNAP	Round to step.	OFF or ON	ON	-	SA
4	AGC TH	AGC Threshold.	From 0 to 10	4	-	TH
6	AUX VOL	Auxiliary output volume.	From 0 to 100	50	-	VA
7	QUICKSTEP	Step selected for the "QuickStep" mode.	1Hz, 5Hz, 10Hz, 25Hz, 50Hz, 100Hz, 250Hz, 500Hz, 1kHz, 2kHz, 3kHz, 4.5kHz, 5kHz, 7.5kHz, 9kHz, 10kHz, 12.5kHz, 25kHz, 50kHz, 100kHz, 125kHz, 250kHz, 500kHz, 1MHz	1kHz	-	QS
8	CW MUTE	Sets the mute status during CW transmission.	OFF or ON	OFF	-	MT
9	xSB MUTE	Sets the mute status during AM, FM or SSB transmission.	OFF or ON	ON	-	MT
10	FILBYPASS	Sets the pre-selection filters bypass, available only in reception in remote/mixed mode and in split.	OFF or ON	OFF	-	BP
11	TONE VOL	Sidetone volume.	From 0 to 100	5	-	VT
12	SET CW MODE	Enables/disables the CW reverse mode.	YES or NO	NO	-	MD
14	FM MODE	Enable / disable FM mode.	OFF or ON	ON	-	FM

Menu	Title	Description	Available Settings	Default	Main Knob Use	Relative CAT Command
15	RIT STEP	Step value for managing the RIT. If the value set is "none" the old operation mode is used (without step but digit by digit), if the value set is in Hz, the new operation mode is used (with step).	None, 1Hz, 5Hz, 10Hz, 25Hz, 50Hz, 100Hz, 250Hz, 500Hz, 1kHz	10Hz	-	RN
TRANSMISSION MENUS						
30	TX ENABLE	Enables the transmission.	OFF or ON	ON	-	TE
31	ANTENNAS	Number of antenna used.	1 or 2	1	-	AN
32	TX IN	Transmission input in AM, FM and SSB. The TXIN setting is automatically set to MIC if the PTT button is pressed or USB if the CAT command TX is received.	Microphone, USB soundcard, AUTO	Microphone	-	TI
33	TXOUT	Transmission output selection.	PWR (ant. RTX) or 0dBm (RFOUT)	PWR	-	TT
34	TX POWER	Transmission power selection.	0.1W to 5.0W in 0.1W steps or max available	5W	Yes	TP/TQ
35	TX BW	Transmission filter selection for FM, AM and SSB mode.	50Hz - 4000Hz 100Hz - 2700Hz 100Hz - 3000Hz 100Hz - 3500Hz 100Hz - 4000Hz 200Hz - 2700Hz 200Hz - 3000Hz 200Hz - 3500Hz 200Hz - 4000Hz 300Hz - 2700Hz 300Hz - 3000Hz 300Hz - 3500Hz 300Hz - 4000Hz	100Hz - 2700Hz	-	TB
36	MIC GAIN	Microphone Gain.	±12dB in step of 0.5dB	0dB	-	MG

Menu	Title	Description	Available Settings	Default	Main Knob Use	Relative CAT Command
37	CW IN	CW transmission input selection. The Key+DTR option appears only when the USB is connected and is automatically disabled when the USB is disconnected, re-setting the selection to Key. This is done to avoid unwanted TX operations due to USB setup transient phases.	Key, Paddle, Key+DTR, Paddle+DTR	Key	-	CI
38	CW DELAY	PTT release delay in CW.	0 to 9000ms	240ms	Yes	CD
39	CW KEY	Selects where the key is connected on the key/paddle jack.	TIP or RING	TIP	-	KT
40	CW TIP	Selects the dot or dash on the tip of the key/paddle jack.	DOT or DASH	DASH	-	KT
41	CW IAMBIC	Sets the iambic mode.	A or B	A	-	IA
42	CW RX WPM	CW characters decoding speed.	5 to 90 words per minute	12	Yes	CS
43	CW RX TH	CW threshold for a tone recognition.	AUTO or from 1 to 10	AUTO	-	WT
44	CW DECODE	Enables/disables the automatic CW decoding.	OFF or ON	OFF	-	DE
45	CW TX WPM	CW transmission speed.	5 to 90 words per minute	10	Yes	CS
46	CW MSG	CW message selection.	Msg 1 to Msg 10	Msg 1	-	SW
47	TX VIEW	Selects the default parameter to be displayed during a transmission.	Frequency, forward power, reflected power, SWR	Forward power	-	TV
48	UP/DOWN ACC	MIC UP / DOWN acceleration of the microphone buttons.	1, 2, 3	2	-	UD
49	TUNE TIME	Antenna tuning mode timeout. Active only if the selected transmission output is the antenna. Not active in service mode.	3 to 120 seconds	10s	-	TU
50	ATT ON TX	Attenuation in transmission mode.	OFF or ON	OFF	-	AX
51	NOISE TH	Sets the noise gate threshold. Available only if TXIN is set to MIC.	OFF,1,2,... 10	2	-	NT
52	COMP GAIN	Sets dynamic compression gain. Available only if TXIN is set to MIC.	OFF,1,2,... 10	7	-	CG
53	TX FM DEV	Transmission FM deviation.	2.5kHz, 5kHz	2.5kHz	-	FD

Menu	Title	Description	Available Settings	Default	Main Knob Use	Relative CAT Command
54	PTT	PTT control.	PTT, PTT+RTS	PTT	-	TR
55	TUNE POWER	Sets the TUNE power.	0.3W, 0.5W, 1W, 1.2W, 1.5W, 2W, 3W, 4W, 5W or max available	5W	-	TL
56	TUNE PTT	Sets the PTT OUT behavior when in tune mode.	YES or NO	YES	-	PT
57	PTT DELAY	PTT OUT anticipation and delay in SSB, AM and FM.	0 to 1000ms	0ms	Yes	PD
58	PTT ON CW	Sets the microphone PTT key behavior when CW mode is selected.	CW message preparation, PTT out assertion	CW message preparation	-	TC
59	AUT CW TX	Sets the automatic CW transmission feature behavior.	Off, returns previous mode after transmission, stays in CW mode after transmission	Off	-	CK
GENERAL SETTINGS MENUS						
60	FR OFFSET	Enables/disables the frequency offset for the visualization.	OFF or ON	OFF	-	OS
61	OFS VALUE	Frequency offset value for the visualization.	+/- 99.99999999 GHz. See Frequency visualization offset menu	0Hz	Yes	OV/OW
62	F4	Selects the F4 key function when a long pressure is applied.	None / Send CW Message / Split / Main encoder tuning lock / Switch between CW and CWR	Send CW Message	-	FF
63	F5	Selects the F5 key function when a long pressure is applied.	None / Send CW Message / Split / Main encoder tuning lock / Switch between CW and CWR	Main encoder tuning lock	-	FF
70	CAT BAUD	CAT serial port baud rate.	9600, 38400, 57600, 115200	38400	-	BR
71	HOLD TIME	Hold time to detect a long pressure.	From 500 to 2500ms	1000ms	-	HT
72	REPT TIME	Repetition time when a key is pressed.	From 100 to 1500ms	600ms	-	ET

Menu	Title	Description	Available Settings	Default	Main Knob Use	Relative CAT Command
73	TX BACKLIGHT ON/OFF	Activates backlight when changing operating mode : Rx Stand Alone, Rx Remote, Tx Stand Alone, Tx Remote.	YES or NO	YES	-	BH
SERVICE MENUS						
80	SERVICE	Enables Service mode.	ON or OFF	OFF	-	SE
81	DEFAULT	Restores default parameters.	YES or NO	NO	-	DF
82	UI UPDATE	If Service mode is active, enables the firmware update mode.	YES or NO	NO	-	UU
83	VIEW SN	Displays the FDM-DUO serial number.	Parts of the SN	First part	-	SN
84	VIEW FW	Displays the FDM-DUO firmware versions.	Firmware	UI	-	VS
85	CLK ADJ	Sets the internal clock correction value. It is used to have a fine frequency setting. In case of "Ref In" utilization, this parameter is not relevant.	±50000 dots (not Hz)	-	Yes	CJ

5.9.1 Frequency visualization offset menu

The frequency visualization offset is helpful when using a transverter. The Frequency offset is set in digit by digit mode with some improvements to set a signed 10 digit offset in a 9 digit display.

- E2: Select the digit to modify
- Main encoder: modify the selected digit value
- E1: change the visualization
 - kHz: the 8 most significant digit of the frequency offset are displayed
 - Hz: the 9 least significant digit of the frequency offset are displayed
- E1 or Main encoder short pressure: change the sign of the offset (+/-)
- E2 short pressure: save the setting

EXAMPLES:

Frequency offset value: +10,000,034,120 Hz

- kHz Display mode



- Hz Display mode



5.10 Transmission source

The transmission source in AM, FM and SSB modes depends on the TX IN setting (menu 32) and on what does the user. The table below shows the different possibilities.

User action	Source		
	TX IN = MIC	TX IN = USB	TX IN = AUTO
PTT push on microphone	Microphone	TX USB port	Microphone
TX CAT command sending	Microphone	TX USB port	TX USB port
RTS signal assertion*	Microphone	TX USB port	TX USB port

* to use RTS as PTT, enable the functionality in the PTT menu (number 54).

6 CAT Remote Control

6.1 General Specifications

The FDM-DUO transceiver uses a full-duplex, asynchronous, USB serial interface for communicating through the USB CAT port. Each data is constructed with 1 start bit, 8 data bits, 1 stop bit, no parity is used (8N1). The baud rate is selectable in the [70] CAT BAUD menu. Available values are 9600, 38400, 57600, 115200 bps.

The FDM-DUO implements proprietary commands and also a subset of the Kenwood TS-480 command set. Some of those TS-480 commands have no effect on the transceiver, they only ensure the compatibility of the FDM-DUO with Ham Radio Deluxe.

6.2 Commands Types

A CAT command is composed of an alphabetical part, various parameters and a terminator that signals the end of the command. For example to set the VFO-A to 14MHz the command is: "FA00014000000;" with :

- "FA": alphabetical command,
- "00014000000": parameter,
- ";": terminator.

CAT commands can be classified as shown below:

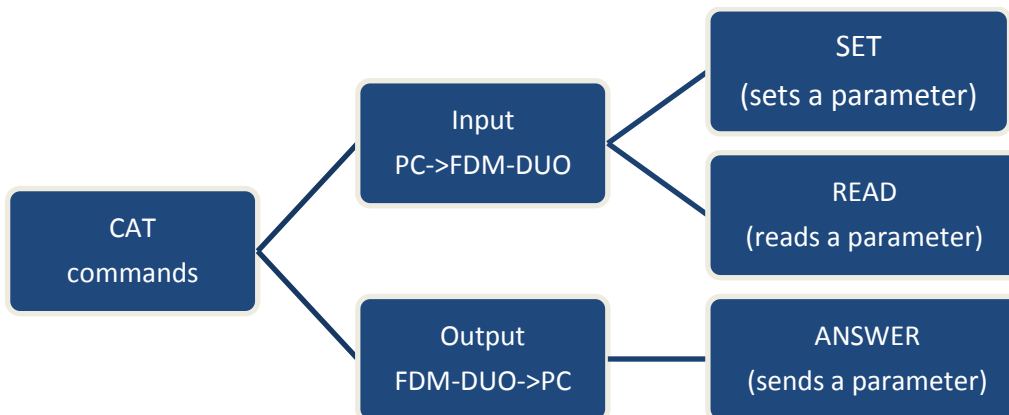

EXAMPLE

- To set the VFO-A to 14MHz the PC sends the **SET command type** "FA00014000000;"
- To read the VFO-A frequency the PC sends the **READ command type** "FA;", the **ANSWER response type** is returned to the PC: "FA00014000000;".

NOTE

Some particular rules about the CAT commands on the FDM-DUO :

- not all the commands have the three types of command/response (**SET**, **READ** and **ANSWER**),
- normally, send the **SET command type** will not cause the FDM-DUO to send the **ANSWER response type** but if a command does not have a **READ command type** and has the **SET and ANSWER type**, then send the **SET command** will cause the FDM-DUO to send the **ANSWER response type**.

6.3 Cat Commands

6.3.1 Commands list

COMMAND	FUNCTION	SET	READ	ANS.
AC	TUNE MODE STATUS	-	YES	YES
AN	ANTENNAS	YES	YES	YES
AT	RF ATTENUATOR	YES	YES	YES
AX	ATTENUATION ON TRANSMISSION	YES	YES	YES
BH	BACKLIGHT CHANGE	YES	YES	YES
BP	FILTERS BYPASS	YES	YES	YES
BR	BAUD RATE	YES	YES	YES
CD	CW DELAY	YES	YES	YES
CG	TX COMPRESSION GAIN	YES	YES	YES
CI	CW INPUT	YES	YES	YES
CK	AUTO CW TX WHEN KEYED	YES	YES	YES
CM	CW MESSAGE	YES	YES	YES
CP	CW PARTIAL MESSAGE	YES	YES	YES
CS	CW SPEEDS	YES	YES	YES
DE	CW DECODE	YES	YES	YES
DF	DEFAULT	YES	-	YES
DT	DUO TYPE	-	YES	YES
ET	REPEAT TIME	YES	YES	YES
FA	VFO-A FREQUENCY	YES	YES	YES
FB	VFO-B FREQUENCY	YES	YES	YES
FD	FM DEVIATION	YES	YES	YES
FF	FX FUNCTIONS	YES	YES	YES
FM	FM MODE ACTIVATION	YES	YES	YES
FP	READS THE FORWARD POWER	-	YES	YES
FR	VFO/MEM MODE	YES	YES	YES
FT	VFO/MEM MODE	YES	YES	YES
GC	GAIN CONTROL	YES	YES	YES
GI	GENERAL INFORMATION	-	YES	YES
GS	GAIN SETTINGS	YES	YES	YES
HT	HOLD TIME	YES	YES	YES
IA	IAMBIC MODE	YES	YES	YES
IF	INFORMATION	-	YES	YES
IQ	TX IQ MODE	YES	YES	YES
KT	KEY AND TIP	YES	YES	YES
LB	LCD BACKLIGHT	YES	YES	YES
LP	LOW PASS	YES	YES	YES
MA	READ VFO-A MODE	-	YES	YES
MB	READ VFO-B MODE	-	YES	YES
MC	MEMORY CHANNEL	YES	YES	YES
MD	MODE	YES	YES	YES
MG	MIC GAIN	YES	YES	YES
MR	MEMORY READ	-	YES	YES
MT	MUTE IN TRANSMISSION	YES	YES	YES
MW	MEMORY WRITE	YES	-	-
NB	NOISE BLANKER STATUS	-	YES	YES
NC	NOISE REDUCTION	YES	YES	YES
NK	NOISE BLANKER	YES	YES	YES
NO	AUTO NOTCH	YES	YES	YES
NR	NOISE REDUCTION STATUS	-	YES	YES
NT	TX NOISE THRESHOLD	YES	YES	YES
OS	FVO STATE	YES	YES	YES

COMMAND	FUNCTION	SET	READ	ANS.
OV	FVO VALUE	YES	YES	YES
OW	FVO VALUE	YES	YES	YES
PD	PTT DELAY	YES	YES	YES
PI	PITCH	YES	YES	YES
PT	PTT OUT IN TUNE	YES	YES	YES
QS	QUICK STEP	YES	YES	YES
RA	RF ATTENUATOR	YES	YES	YES
RC	RIT CLEAR	YES	-	-
RD	RIT DOWN	YES	YES	YES
RF	RECEPTION FILTERS	YES	YES	YES
RI	READS RSSI	-	YES	YES
RN	RIT STEP	YES	YES	YES
RP	READS THE REFLECTED POWER	-	YES	YES
RT	RIT STATUS	YES	YES	YES
RU	RIT UP	YES	YES	YES
RV	RIT VALUE	YES	YES	YES
RX	RX SET	YES	-	YES
SA	TUNE SNAP	YES	YES	YES
SE	SERVICE	YES	YES	YES
SF	SPF08 FILTERS	YES	YES	YES
SI	VFO STEP INDEX	YES	YES	YES
SM	S METER	-	YES	YES
SN	SERIAL NUMBER	-	YES	YES
SP	SPLIT	YES	YES	YES
SQ	SQUELCH	YES	YES	YES
SW	SEND/SET CW MESSAGE	YES	YES	YES
TB	TRANSMISSION BANDWIDTH	YES	YES	YES
TC	PTT ACTION FOR CW	YES	YES	YES
TE	TX ENABLE	YES	YES	YES
TH	AGC THRESHOLD	YES	YES	YES
TI	TRANSMISSION INPUT	YES	YES	YES
TL	TUNE POWER LEVEL	YES	YES	YES
TP	TRANSMISSION POWER LEVEL	YES	YES	YES
TQ	TANSMISSION POWER FINE LEVEL	YES	YES	YES
TR	PTT WITH RTS	YES	YES	YES
TT	TRANSMISSION OUTPUT	YES	YES	YES
TU	TUNE TIME OUT	YES	YES	YES
TV	TX VIEW	YES	YES	YES
TX	TX SET	YES	-	YES
UD	UD DOWN ACC	YES	YES	YES
UU	UI UPDATE	YES	-	YES
VA	AUX VOLUME	YES	YES	YES
VE	VFOs EQUAL	YES	-	YES
VM	MAIN VOLUME	YES	YES	YES
VS	FIRMWARE VERSION	-	YES	YES
VT	SIDETONE VOLUME	YES	YES	YES
WR	READS THE SWR VALUE	-	YES	YES
WT	CW RX THRESHOLD	YES	YES	YES

FVO : Frequency Visualization Offset (for transverter use)

RIT : Receive Incremental Tuning

RSSI : Received Signal Strength Indicator

6.3.2 Commands tables

AC	Reads the tune mode status										Parameters: P1: always '0' P2: always '0' P3 : '0': not active '1': active
Set											
Read	1	2	3	4	5	6	7	8	9	10	
Answer	A	C	;								
	1	2	3	4	5	6	7	8	9	10	
	A	C	P1	P2	P3	;					

AN	Reads or selects the number of antennas used										Parameters: P1: '1': only one antenna '2': two antennas, one for reception and another one for transmission
Set	1	2	3	4	5	6	7	8	9	10	
Read	1	2	3	4	5	6	7	8	9	10	
Answer	A	N	;								
	1	2	3	4	5	6	7	8	9	10	
	A	N	P1	;							

AT	Reads or sets the input attenuator status										Parameters: P1 : '0' : not active '1' : active
Set	1	2	3	4	5	6	7	8	9	10	
Read	1	2	3	4	5	6	7	8	9	10	
Answer	A	T	;								
	1	2	3	4	5	6	7	8	9	10	
	A	T	P1	;							

AX	Reads or sets the attenuator status during transmission										Parameters: P1 : '0' : not active '1' : active
Set	1	2	3	4	5	6	7	8	9	10	
Read	1	2	3	4	5	6	7	8	9	10	
Answer	A	X	;								
	1	2	3	4	5	6	7	8	9	10	
	A	X	P1	;							

BH	Enables or disables the backlight change when moving between modes (Rx Stand Alone, Rx Remote, Tx Stand Alone, Tx Remote)										Parameters: P1 : '0' : off '1' : on
	Set not available during transmission										
Set	1	2	3	4	5	6	7	8	9	10	
Read	1	2	3	4	5	6	7	8	9	10	
Answer	B	H	;								
	1	2	3	4	5	6	7	8	9	10	
	B	H	P1	;							

BP	Enables or disables the pre-selection filters bypass										Parameters: P1 : '0' : off '1' : on
	Set not available during transmission										
Set	1	2	3	4	5	6	7	8	9	10	
	B	P	P1	;							
Read	1	2	3	4	5	6	7	8	9	10	
	B	P	;								
Answer	1	2	3	4	5	6	7	8	9	10	
	B	P	P1	;							

BR	Reads or sets the baud rate value										Parameters: P1 : '0': 9600 '1': 38400 '2': 57600 '3': 115200
	Set not available during transmission										
Set	1	2	3	4	5	6	7	8	9	10	
	B	R	P1	;							
Read	1	2	3	4	5	6	7	8	9	10	
	B	R	;								
Answer	1	2	3	4	5	6	7	8	9	10	
	B	R	P1	;							

CD	Reads or sets the CW delay value										Parameters: P1 : 0 ~ 1000 (in ms)
	Set not available during transmission										
Set	1	2	3	4	5	6	7	8	9	10	
	C	D	P1	P1	P1	P1	;				
Read	1	2	3	4	5	6	7	8	9	10	
	C	D	;								
Answer	1	2	3	4	5	6	7	8	9	10	
	C	D	P1	P1	P1	P1	;				

CG	Reads or sets the transmitter compression gain										Parameters: P1: always '0' P2 : compression gain value "000" : OFF "001" ~ "010" : active
	Set not available during transmission										
Set	1	2	3	4	5	6	7	8	9	10	
	C	G	P1	P2	P2	P2	;				
Read	1	2	3	4	5	6	7	8	9	10	
	C	G	P1	;							
Answer	1	2	3	4	5	6	7	8	9	10	
	C	G	P1	P2	P2	P2	;				

CI	Reads/Sets CW input										Parameters: P1 : '0' : key '1' : paddle '2': key + DTR '3': paddle + DTR
	Set not available during transmission Set possible with "+ DTR" only if : - USB CAT cable inserted, - DTR signal stable, - DTR signal at the idle level.										
Set	1	2	3	4	5	6	7	8	9	10	
	C	I	P1	;							
Read	1	2	3	4	5	6	7	8	9	10	
	C	I	;								
Answer	1	2	3	4	5	6	7	8	9	10	
	C	I	P1	;							

CK	Sets or reads the status of the CW automatic transmission function										Parameters: P1 : '0': off '1': on, returns in the previous set mode after the transmission '2': on, stays in CW mode after the transmission
	Set not available during transmission										
Set	1	2	3	4	5	6	7	8	9	10	
	C	K	P1	;							
Read	1	2	3	4	5	6	7	8	9	10	
	C	K	;								
Answer	1	2	3	4	5	6	7	8	9	10	
	C	K	P1	;							

CM	Reads or sets CW messages										Parameters: P1 : CW Message Index (0 To 9) P2 : CW Message text (ASCII)
	Set not available during transmission See also CP and SW commands										
Set	1	2	3	4	5	6	7	8	9	10	
	C	M	P1	P1	P2	P2	P2	P2	P2	P2	
	11	12	13	14	15	16	17	18	19	20	
	P2	P2	P2	P2	P2	P2	P2	P2	P2	P2	
	21	22	23	24	25	26	27	28	29	30	
	P2	P2	P2	P2	P2	P2	P2	P2	P2	P2	
Read	1	2	3	4	5	6	7	8	9	10	
	C	M	P1	P1	;						
Answer	1	2	3	4	5	6	7	8	9	10	Allowed characters are: ABCDEFGHIJKLMNQRSTUUVW XYZ '(space) 0123456789 ! " & ' () + , - . / : = ? @ _ A fixed length of 32 is used for P2, unused characters at the end of the message must be '(space).
	C	M	P1	P1	P2	P2	P2	P2	P2	P2	
	11	12	13	14	15	16	17	18	19	20	
	P2	P2	P2	P2	P2	P2	P2	P2	P2	P2	
	21	22	23	24	25	26	27	28	29	30	
	P2	P2	P2	P2	P2	P2	P2	P2	P2	P2	
Read	1	2	3	4	5	6	7	8	9	10	
	C	M	P1	P1	;						
Answer	1	2	3	4	5	6	7	8	9	10	
	C	M	P1	P1	P2	P2	P2	P2	P2	P2	
	11	12	13	14	15	16	17	18	19	20	
	P2	P2	P2	P2	P2	P2	P2	P2	P2	P2	
	21	22	23	24	25	26	27	28	29	30	
	P2	P2	P2	P2	P2	P2	P2	P2	P2	P2	

CP	Reads or sets CW messages in a partial way										Parameters: P1 : part index (0 to 3) P2 : CW message index (0 to 9) P3 : part of CW message (ASCII)
	Set not available during transmission See also CM and SW commands										
Set	1	2	3	4	5	6	7	8	9	10	
	C	P	P1	P2	P2	P3	P3	P3	P3	P3	
	11	12	13	14	15	16	17	18	19	20	
Read	1	2	3	4	5	6	7	8	9	10	
	C	P	P1	P2	P2	;					
Answer	1	2	3	4	5	6	7	8	9	10	Allowed characters are: ABCDEFGHIJKLMNQRSTUUVW XYZ '(space) 0123456789 ! " & ' () + , - . / : = ? @ _ A fixed length of 10 is used for P3, unused characters at the end of the message must be '(space).
	C	P	P1	P2	P2	P3	P3	P3	P3	P3	
	11	12	13	14	15	16					
Read	1	2	3	4	5	6	7	8	9	10	
	C	P	P1	P2	P2	;					

CS	Reads or sets the CW speeds										Parameters: P1: '0' : sets both speeds '1' : set only the decoding speed '2' : set only the transmission speed P2: decoding speed of CW characters (5 to 90 WPM) P3: transmission speed of CW characters (5 to 90 WPM)
Set	1	2	3	4	5	6	7	8	9	10	
	C	S	P1	P2	P2	P2	P3	P3	P3	;	
Read	1	2	3	4	5	6	7	8	9	10	
	C	S	;								
Answer	1	2	3	4	5	6	7	8	9	10	
	C	S	P2	P2	P2	P3	P3	P3	;		

DE	Sets or reads the CW decode function status										Parameters: P1 : '0' : off '1' : on
See also WT command											
Set	1	2	3	4	5	6	7	8	9	10	
	D	E	P1	;							
Read	1	2	3	4	5	6	7	8	9	10	
	D	E	;								
Answer	1	2	3	4	5	6	7	8	9	10	
	D	E	P1	;							

DF	Sets the default value										Parameters: P1 : always '1' P2 : "5214" P3 : result : '0' error '1' ok
Set not available during transmission											
Set	1	2	3	4	5	6	7	8	9	10	
	D	F	P1	P2	P2	P2	P2	;			
Read											
Answer	1	2	3	4	5	6	7	8	9	10	
	D	F	P3	;							

DT	Reads the FDM-DUO type										Parameters: P1 : always "001"
Set											
Read	1	2	3	4	5	6	7	8	9	10	
	D	T	;								
Answer	1	2	3	4	5	6	7	8	9	10	
	D	T	P1	P1	P1	;					

ET	Reads or sets the repeat time setting										Parameters: P1: repeat time, from 100ms to 1500ms in 100ms steps.
Set	1	2	3	4	5	6	7	8	9	10	
	E	T	P1	P1	P1	P1	;				
Read	1	2	3	4	5	6	7	8	9	10	
	E	T	;								
Answer	1	2	3	4	5	6	7	8	9	10	
	E	T	P1	P1	P1	P1	;				

FA	Reads or sets the VFO A frequency										Parameters: P1 : frequency in Hz (11 digit)
	Set not available during power transmission										
Set	1	2	3	4	5	6	7	8	9	10	
	F	A	P1	P1	P1	P1	P1	P1	P1	P1	
	11	12	13	14	15	16	17	18	19	20	
Read	1	2	3	4	5	6	7	8	9	10	
	F	A	;								
Answer	1	2	3	4	5	6	7	8	9	10	
	F	A	P1	P1	P1	P1	P1	P1	P1	P1	
	11	12	13	14	15	16	17	18	19	20	
	P1	P1	P1	;							

FB	Reads or sets the VFO B frequency										Parameters: P1 : frequency in Hz (11 digit)
	Set not available during power transmission										
Set	1	2	3	4	5	6	7	8	9	10	
	F	B	P1	P1	P1	P1	P1	P1	P1	P1	
	11	12	13	14	15	16	17	18	19	20	
Read	1	2	3	4	5	6	7	8	9	10	
	F	B	;								
Answer	1	2	3	4	5	6	7	8	9	10	
	F	B	P1	P1	P1	P1	P1	P1	P1	P1	
	11	12	13	14	15	16	17	18	19	20	
	P1	P1	P1	;							

FD	Reads or sets the FM deviation for the transmission										Parameters: P1 : always 0 P2 : '0' : 2.5kHz '1' : 5kHz
	Set not available during transmission										
Set	1	2	3	4	5	6	7	8	9	10	
	F	D	P1	P2	;						
Read	1	2	3	4	5	6	7	8	9	10	
	F	D	;								
Answer	1	2	3	4	5	6	7	8	9	10	
	F	D	P1	P2	;						

FF	Reads or sets the F4 and F5 function settings										Parameters: P1 : '4' : set F4 '5' : set F5 P2 : FX settings: "00": nothing "01": CW message transmission "02": on/off split "03": encoder block "04": CW change (normal/reverse)
	Set not available during transmission										
Set	1	2	3	4	5	6	7	8	9	10	
	F	F	P1	P2	P2	;					
Read	1	2	3	4	5	6	7	8	9	10	
	F	F	P1	;							
Answer	1	2	3	4	5	6	7	8	9	10	
	F	F	P1	P2	P2	;					

FM	Reads or sets the FM mode activation status										Parameters: P1 : '0': FM mode not available '1': FM mode available
Set	1	2	3	4	5	6	7	8	9	10	
	F	M	P1	;							
Read	1	2	3	4	5	6	7	8	9	10	
	F	M	;								
Answer	1	2	3	4	5	6	7	8	9	10	
	F	M	P1	;							

FP	Reads forward power										Parameters: P1: ' '(blank) o '!' in case of an unreliable power value, i.e. : - DUO is in RX mode - DUO is in TX mode with 0dBm P2 : forward power
Set											
Read	1	2	3	4	5	6	7	8	9	10	
	F	P	;								
Answer	1	2	3	4	5	6	7	8	9	10	
	F	P	P1	P2	P2	P2	P2	P2	P2	;	

FR	Reads or sets the VFO or M.CH mode										Parameters: P1 : '0' : VFO-A '1' : VFO-B '2' : M.CH
Set not available during transmission											
Set	1	2	3	4	5	6	7	8	9	10	
	F	R	P1	;							
Read	1	2	3	4	5	6	7	8	9	10	
	F	R	;								
Answer	1	2	3	4	5	6	7	8	9	10	
	F	R	P1	;							

FT	Reads or sets the VFO or M.CH mode										Parameters: P1 : '0' : VFO-A '1' : VFO-B '2' : M.CH
Set not available during transmission											
Set	1	2	3	4	5	6	7	8	9	10	
	F	R	P1	;							
Read	1	2	3	4	5	6	7	8	9	10	
	F	R	;								
Answer	1	2	3	4	5	6	7	8	9	10	
	F	R	P1	;							

GC	Reads or sets the active gain control										Parameters: P1 : '0' : auto (AGC) '1' : manual
See also GS and TH commands											
Set	1	2	3	4	5	6	7	8	9	10	
	G	C	P1	;							
Read	1	2	3	4	5	6	7	8	9	10	
	G	C	;								
Answer	1	2	3	4	5	6	7	8	9	10	
	G	C	P1	;							

GI	Reads DUO's status										Parameters:
Set											P1 : RIT status: '0' : OFF '1' : ON
Read	1	2	3	4	5	6	7	8	9	10	P2 : always '0'
Answer	G	I	;								P3 : selected memory index (0-199)
	1	2	3	4	5	6	7	8	9	10	P4 : Rx/Tx status '0' : Rx '1' : Normal Tx '2' : Tune Tx
	G	I	P1	P2	P3	P3	P4	P5	P6		P5 : Current mode (See MD command)
	11	12	13	14	15	16	17	18	19	20	P6 : Current VFO-MEM mode : '0' : VFO-A '1' : VFO-B '2' : MEM
	P7	P8	P8	P8	P8	;					P7 : split status: '0' : split off '1' : stand-alone split on '2' : remote split on
											P8 : always "0000"

GS	Reads or sets the control gain settings										Parameters:
	See also GC and TH commands										P1: 0: auto (AGC) 1: manual
Set	1	2	3	4	5	6	7	8	9	10	P2 for P1='0': 0 : slow 1 : medium 2 : fast
Read	G	S	P1	P2	P2	P2	;				P2 for P1='1': 0 : OFF 1 a 10 : active
Answer	1	2	3	4	5	6	7	8	9	10	
	G	S	P1	P2	P2	P2	;				

HT	Reads or sets the hold time setting										Parameters: P1: hold time, from 200ms to 2500ms in 100ms steps.
Set	1	2	3	4	5	6	7	8	9	10	
	H	T	P1	P1	P1	P1	;				
Read	1	2	3	4	5	6	7	8	9	10	
	H	T	;								
Answer	1	2	3	4	5	6	7	8	9	10	
	H	T	P1	P1	P1	P1	;				

IA	Reads or sets the CW iambic mode										Parameters: P1 : '0' : mode A '1' : mode B
Set not available during transmission											
Set	1	2	3	4	5	6	7	8	9	10	
	I	A	P1	;							
Read	1	2	3	4	5	6	7	8	9	10	
	I	A	;								
Answer	1	2	3	4	5	6	7	8	9	10	
	I	A	P1	;							

IF	Retrieves the transceiver status										Parameters: P1: Frequency 11 digit P2: 5 spaces P3: RIT value in tens of hertz P4: RIT state 0: OFF 1: ON P5: Always 0 P6/P7: Memory ch. Number 0-199 P8: 0:Rx, 1:Tx P9: Operating Mode (See MD) P10: See FR, FT P11: Always 0 P12: 0:Normal, 1:Split P13: Always 0 P14: Always 0 P15: Space
Set											
Read	1	2	3	4	5	6	7	8	9	10	
	I	F	;								
Answer	1	2	3	4	5	6	7	8	9	10	
	I	F	P1	P1	P1	P1	P1	P1	P1	P1	
	11	12	13	14	15	16	17	18	19	20	
	P1	P1	P1	P2	P2	P2	P2	P2	P3	P3	
	21	22	23	24	25	26	27	28	29	30	
	P3	P3	P3	P4	P5	P6	P7	P7	P8	P9	
31	32	33	34	35	36	37	38	39	40		
	P10	P11	P12	P13	P14	P14	P15	;			

IQ	Reads or sets the IQ transmission mode status. It is necessary to send the "IQ1;" set command before the end of the time out to maintain the IQ mode active										Parameters: P1 '0' : not active '1' : active
Set available during transmission only to reset the time out											
Set	1	2	3	4	5	6	7	8	9	10	
	I	Q	P1	;							
Read	1	2	3	4	5	6	7	8	9	10	
	I	Q	;								
Answer	1	2	3	4	5	6	7	8	9	10	
	I	Q	P1	;							

KT	Sets and reads CW Key and CW Tip settings										Parameters: P1: selection of where the key is connected to the paddle/key jack '0': TIP '1': RING P2: DOR or DASH selection on the "tip" of the paddle/key jack '0': DOT '1': DASH
	Set not available during transmission										
Set	1	2	3	4	5	6	7	8	9	10	
	K	T	P1	P2	;						
Read	1	2	3	4	5	6	7	8	9	10	
	K	T	;								
Answer	1	2	3	4	5	6	7	8	9	10	
	K	T	P1	P2	;						

LB	Reads or sets the LCD backlight parameters										Parameters: P1 : mode: 0 : temporary set 1 : Rx Stand Alone 2 : Rx Remote (PC Controlled) 3 : Tx Stand Alone (MIC input) 4 : Tx Remote (USB Audio) 5 : Tx Stand Alone CW P2 : selezione modalità: 1 : Rx Stand Alone 2 : Rx Remote (PC Controlled) 3 : Tx Stand Alone (MIC Input) 4 : Tx Remote (USB Input) 5 : Tx Stand Alone CW P3 : RED component (0 to 100) P4 : GREEN component (0 to 100) P5 : BLUE component (0 to 100)
	Read not available if P1 is 0										
Set	1	2	3	4	5	6	7	8	9	10	
	L	B	P1	P3	P3	P3	P4	P4	P4	P5	
	11	12	13	14	15	16	17	18	19	20	
	P5	P5	;								
Read	1	2	3	4	5	6	7	8	9	10	
	L	B	P2	;							
Answer	1	2	3	4	5	6	7	8	9	10	
	L	B	P2	P3	P3	P3	P4	P4	P4	P5	
	11	12	13	14	15	16	17	18	19	20	
	P5	P5	;								

LP	Sets/Reads the Low-Pass Filter Status										Parameters: P1 '0' : not active '1' : active
Set	1	2	3	4	5	6	7	8	9	10	
	L	P	P1	;							
Read	1	2	3	4	5	6	7	8	9	10	
	L	P	;								
Answer	1	2	3	4	5	6	7	8	9	10	
	L	P	P1	;							

MA	Reads VFO-A current mode										Parameters: P1 : '1': LSB '2': USB '3': CW '4': FM '5': AM '7': CWR
Set											
Read	1	2	3	4	5	6	7	8	9	10	
	M	A	;								
Answer	1	2	3	4	5	6	7	8	9	10	
	M	A	P1	;							

MB	Reads VFO-B current mode										Parameters: P1 : '1': LSB '2': USB '3': CW '4': FM '5': AM '7': CWR
Set											
Read	1	2	3	4	5	6	7	8	9	10	
Answer	1	2	3	4	5	6	7	8	9	10	
	M	B	;								
	M	B	P1	;							

MC	Recalls or reads the Memory channel										Parameters: P1: 0 or 1 P2: 0 to 99
Set	1	2	3	4	5	6	7	8	9	10	
Read	1	2	3	4	5	6	7	8	9	10	
Answer	1	2	3	4	5	6	7	8	9	10	
	M	C	P1	P2	P2	;					
	M	C	P1	P2	P2	;					

MD	Recalls or reads the operating mode status										Parameters: P1: '1': LSB '2': USB '3': CW '4': FM '5': AM '7': CWR
Set	1	2	3	4	5	6	7	8	9	10	
Read	1	2	3	4	5	6	7	8	9	10	
Answer	1	2	3	4	5	6	7	8	9	10	
	M	D	P1	;							
	M	D	P1	;							

MG	Reads or sets the microphone gain value										Parameters: P1 74: +12.0dB 73: +11.5dB ... 52: +1.0dB 51: +0.5dB 50: 0.0dB 49: -0.5dB ... 28: -11.0dB 27: -11.5dB 26: -12.0dB
Set	1	2	3	4	5	6	7	8	9	10	
Read	1	2	3	4	5	6	7	8	9	10	
Answer	1	2	3	4	5	6	7	8	9	10	
	M	G	P1	P1	P1	;					
	M	G	P1	P1	P1	;					

MR	Reads the memory channel data										Parameters: P1: 0 P2/P3: 0 to 199 Memory No. P4: Frequency (11 digit) P5: Mode (see MD command) P6: Always 0 P7: Always 0 P8: Always 0 P9: Always 0 P10 to P13: Memory label, last 14 chars P14: 0 P15: Memory status B: used F: free P16: Memory label, first 8 chars
Set											
Read	1	2	3	4	5	6	7	8	9	10	
	M	R	P1	P2	P3	P3					
Answer	1	2	3	4	5	6	7	8	9	10	
	M	R	P1	P2	P3	P3	P4	P4	P4	P4	
	11	12	13	14	15	16	17	18	19	20	
	P4	P4	P4	P4	P4	P4	P4	P5	P6	P7	
	21	22	23	24	25	26	27	28	29	30	
	P8	P8	P9	P9	P10	P10	P10	P10	P10	P10	
	31	32	33	34	35	36	37	38	39	40	
	P10	P10	P10	P10	P10	P10	P10	P10	P11	P12	
	41	42	43	44	45	46	47	48	49	50	
	P15	P16	P16	P16	P16	P16	P16	P16	P16	;	

MT	Reads or sets the mutes status during transmission										Parameters: P1 : CW MUTE '0' : not active '1' : active P2 : SSB MUTE '0' : not active '1' : active
	Set not available during transmission										
Set	1	2	3	4	5	6	7	8	9	10	
	M	T	P1	P2	;						
Read	1	2	3	4	5	6	7	8	9	10	
	M	T	;								
Answer	1	2	3	4	5	6	7	8	9	10	
	M	T	P1	P2	;						

MW	Store the data to the memory channel										Parameters: P1: 0 P2/P3: 0 to 199 Memory No. P4: Frequency (11 digit) P5: Mode (see MD command) P6: Always 0 P7: Always 0 P8: Always 0 P9: Always 0 P10 to P13: Memory label, last 14 chars P14: 0 P15: Memory status B: used F: free P16: Memory label, first 8 chars
Set	1	2	3	4	5	6	7	8	9	10	
	M	W	P1	P2	P3	P3	P4	P4	P4	P4	
	11	12	13	14	15	16	17	18	19	20	
	P4	P4	P4	P4	P4	P4	P4	P5	P6	P7	
	21	22	23	24	25	26	27	28	29	30	
	P8	P8	P9	P6	P10	P10	P10	P10	P10	P10	
	31	32	33	34	35	36	37	38	39	40	
	P10	P10	P10	P10	P10	P10	P10	P10	P11	P12	
	41	42	43	44	45	46	47	48	49	50	
	P15	P16	P16	P16	P16	P16	P16	P16	P16	;	
Read											
Answer											

NB	Reads the noise blanker function status										Parameters: P1 '0' : Noise Blanker OFF '1' : Noise Blanker ON
Set											
Read	1	2	3	4	5	6	7	8	9	10	
	N	B	;								
Answer	1	2	3	4	5	6	7	8	9	10	
	N	B	P1	;							

NC	Reads or sets the noise reduction value										Parameters: P1 : always 0 P2 : noise reduction value: 0 : OFF 1 ~ 10 : active
Set	1	2	3	4	5	6	7	8	9	10	
	N	C	P1	P2	P2	P2	;				
Read	1	2	3	4	5	6	7	8	9	10	
	N	C	P1	;							
Answer	1	2	3	4	5	6	7	8	9	10	
	N	C	P1	P2	P2	P2	;				

NK	Reads or sets the noise blanker value										Parameters: P1 : always '0' P2 : noise blanker value: 0 : OFF 1 ~ 10 : active
Set	1	2	3	4	5	6	7	8	9	10	
	N	K	P1	P2	P2	P2	;				
Read	1	2	3	4	5	6	7	8	9	10	
	N	K	P1	;							
Answer	1	2	3	4	5	6	7	8	9	10	
	N	K	P1	P2	P2	P2	;				

NO	Reads or sets the auto notch value										Parameters: P1 : always '0' P2 : auto notch value: 0 : OFF 1 ~ 2 : active
Set	1	2	3	4	5	6	7	8	9	10	
	N	O	P1	P2	P2	P2	;				
Read	1	2	3	4	5	6	7	8	9	10	
	N	O	P1	;							
Answer	1	2	3	4	5	6	7	8	9	10	
	N	O	P1	P2	P2	P2	;				

NR	Reads the noise reduction function status										Parameters: P1: '0' : Noise Reduction OFF '1' : Noise Reduction ON
Set											
Read	1	2	3	4	5	6	7	8	9	10	
	N	R	;								
Answer	1	2	3	4	5	6	7	8	9	10	
	N	R	P1	;							

NT	Reads or sets the transmitter noise threshold										Parameters: P1 : always '0' P2 : noise threshold value 0 : OFF 1 ~ 10 : active
Set	1	2	3	4	5	6	7	8	9	10	
	N	T	P1	P2	P2	P2	;				
Read	1	2	3	4	5	6	7	8	9	10	
	N	T	P1	;							
Answer	1	2	3	4	5	6	7	8	9	10	
	N	T	P1	P2	P2	P2	;				

OS	Reads or sets the Frequency view offset status										Parameters: P1 : '0' : not active '1' : active
Set not available during transmission See also OV and OW commands											
Set	1	2	3	4	5	6	7	8	9	10	
	O	S	P1	;							
Read	1	2	3	4	5	6	7	8	9	10	
	O	S	;								
Answer	1	2	3	4	5	6	7	8	9	10	
	O	S	P1	;							

OV	Reads or sets the Frequency view offset value										Parameters: P1 : always '0'
	Set not available during transmission See also OS and OW commands										P2 : offset sign '+' / '-'
Set	1	2	3	4	5	6	7	8	9	10	P3 : absolute value in Hz
	O	V	P1	P2	P3	P3	P3	P3	P3	P3	
	11	12	13	14	15	16	17	18	19	20	
Read	1	2	3	4	5	6	7	8	9	10	
	O	V	P1	;							
Answer	1	2	3	4	5	6	7	8	9	10	
	O	V	P1	P2	P3	P3	P3	P3	P3	P3	
	11	12	13	14	15	16	17	18	19	20	
	P3	P3	P3	P3	P3	P3	P3	P3	P3	;	

OW	Sets/Reads the Frequency view offset value										Parameters: P1 : offset sign '+' / '-'
	See also OS and OV commands										P2 : absolute value in Hz
Set	1	2	3	4	5	6	7	8	9	10	
	O	W	P1	P2	P2	P2	P2	P2	P2	P2	
	11	12	13	14	15	16	17	18	19	20	
Read	1	2	3	4	5	6	7	8	9	10	
	O	W	;								
Answer	1	2	3	4	5	6	7	8	9	10	
	O	W	P1	P2	P2	P2	P2	P2	P2	P2	
	11	12	13	14	15	16	17	18	19	20	
	P2	P2	P2	P2	P2	;					

PD	Reads or sets the PTT delay value										Parameters: P1 : PTT delay value in ms: "0000" ~ "1000"
	Set not available during transmission										
Set	1	2	3	4	5	6	7	8	9	10	
	P	D	P1	P1	P1	P1	;				
Read	1	2	3	4	5	6	7	8	9	10	
	P	D	;								
Answer	1	2	3	4	5	6	7	8	9	10	
	P	D	P1	P1	P1	P1	;				

PI	Reads or sets the pitch value										Parameters: P1 : pitch value in Hz: "0000" ~ "1000" in 10Hz step
Set	1	2	3	4	5	6	7	8	9	10	
	P	I	P1	P1	P1	P1	;				
Read	1	2	3	4	5	6	7	8	9	10	
	P	I	;								
Answer	1	2	3	4	5	6	7	8	9	10	
	P	I	P1	P1	P1	P1	;				

PT	Reads or sets the PTT OUT in tune status										Parameters: P1 : "00": OFF "01": ON
	Set not allowed when in Tx										
Set	1	2	3	4	5	6	7	8	9	10	
	P	T	P1	P1	;						
Read	1	2	3	4	5	6	7	8	9	10	
	P	T	;								
Answer	1	2	3	4	5	6	7	8	9	10	
	P	T	P1	P1	;						

QS	Sets or reads the quick step index										Parameters: P1: quickstep index Steps list (in Hz): 1, 5, 10, 25, 50, 100, 250, 500, 1000, 2000, 3000, 4500, 5000, 7500, 9000, 10k, 12.5k, 25k, 50k, 100k, 125k, 250k, 500k, 1M.
Set	1	2	3	4	5	6	7	8	9	10	
	Q	S	P1	P1	;						
Read	1	2	3	4	5	6	7	8	9	10	
	Q	S	;								
Answer	1	2	3	4	5	6	7	8	9	10	
	Q	S	P1	P1	;						

RA	Reads or sets the attenuator function status										Parameters: P1 : "00": ATT OFF "01": ATT ON P2 : always "00"
Set	1	2	3	4	5	6	7	8	9	10	
	R	A	P1	P1	;						
Read	1	2	3	4	5	6	7	8	9	10	
	R	A	;								
Answer	1	2	3	4	5	6	7	8	9	10	
	R	A	P1	P1	P2	P2	;				

RC	Clears the RIT value										Parameters: None
Set	1	2	3	4	5	6	7	8	9	10	
	R	C	;								
Read											
Answer											

RD	Sets RIT to a negative value										Parameters: P1 : negative value of RIT to set (from 0 to 50000Hz, max value subject to change) P2 : always '1'
Set	1	2	3	4	5	6	7	8	9	10	
	R	D	P1	P1	P1	P1	P1	;			
Read	1	2	3	4	5	6	7	8	9	10	
	R	D	;								
Answer	1	2	3	4	5	6	7	8	9	10	
	R	D	P2	;							

RF	Reads or sets the reception filters values										Parameters: P1: '1': LSB '2': USB '3': CW '4': FM '5': AM '7': CWR P2: see parameter details below
Set	1	2	3	4	5	6	7	8	9	10	
	R	F	P1	P2	P2	;					
Read	1	2	3	4	5	6	7	8	9	10	
	R	F	P1	;							
Answer	1	2	3	4	5	6	7	8	9	10	
	R	F	P1	P2	P2	;					

RF command - P2 parameter

P2	MODE			
	LSB/USB	CW/CWR	AM	FM
00	1600Hz	-	2500Hz	Voice Narrow
01	1700Hz	-	3000Hz	Voice Wide
02	1800Hz	-	3500Hz	Data
03	1900Hz	-	4000Hz	-
04	2000Hz	-	4500Hz	-
05	2100Hz	-	5000Hz	-
06	2200Hz	-	5500Hz	-
07	2300Hz	100Hz & 4	6000Hz	-
08	2400Hz	100Hz & 3	-	-
09	2500Hz	100Hz & 2	-	-
10	2600Hz	100Hz & 1	-	-
11	2700Hz	100Hz	-	-
12	2800Hz	300Hz	-	-
13	2900Hz	500Hz	-	-
14	3000Hz	1000Hz	-	-
15	3100Hz	1500Hz	-	-
16	4000Hz	2600Hz	-	-
17	5000Hz	-	-	-
18	6000Hz	-	-	-
19	DATA 300Hz	-	-	-
20	DATA 600Hz	-	-	-
21	DATA 1000Hz	-	-	-

RI	Reads RSSI										Parameters: P1 : '-' : negative value '+' : positive value '!' : unreliable value P2 :RSSI absolute value
Set											
Read	1	2	3	4	5	6	7	8	9	10	
	R	I	;								
Answer	1	2	3	4	5	6	7	8	9	10	
	R	I	P1	P2	P2	P2	P2	;			

RN	Reads or sets the RIT step index										Parameters: P1: RIT step index '0': none '1': 1Hz '2': 5Hz '3': 10Hz '4': 25Hz '5': 50Hz '6': 100Hz '7': 250Hz '8': 500Hz '9': 1000Hz
Set	1	2	3	4	5	6	7	8	9	10	
	R	N	P1	;							
Read	1	2	3	4	5	6	7	8	9	10	
	R	N	;								
Answer	1	2	3	4	5	6	7	8	9	10	
	R	N	P1	;							

RP	Reads reflected power										Parameters: P1: ' ' (blank) or '!' in case of an unreliable power value, i.e. : - DUO is in RX mode - DUO is in TX mode with OdBm P2 : reflected power
Set											
	R	P	;								
Read	1	2	3	4	5	6	7	8	9	10	
	R	P	;								
Answer	1	2	3	4	5	6	7	8	9	10	
	R	P	P1	P2	P2	P2	P2	P2	P2	;	

RT	Reads or sets the RIT function status										Parameters: P1: '0' : RIT function OFF '1' : RIT function ON
Set	1	2	3	4	5	6	7	8	9	10	
	R	T	P1	;							
Read	1	2	3	4	5	6	7	8	9	10	
	R	T	;								
Answer	1	2	3	4	5	6	7	8	9	10	
	R	T	P1	;							

RU	Sets RIT to a positive value										Parameters: P1: ositive value of RIT to set (from 0 to 50000Hz, max value subject to change) P2: always '1'
Set	1	2	3	4	5	6	7	8	9	10	
	R	U	P1	P1	P1	P1	P1	;			
Read	1	2	3	4	5	6	7	8	9	10	
	R	U	;								
Answer	1	2	3	4	5	6	7	8	9	10	
	R	U	P2	;							

RV	Reads or sets the RIT value										Parameters: P1: '+': positive or null value '-': negative value P2: absolute value of RIT to set (from 0 to 50000Hz, max value subject to change)
Set	1	2	3	4	5	6	7	8	9	10	
	R	V	P1	P2	P2	P2	P2	P2	P2	;	
Read	1	2	3	4	5	6	7	8	9	10	
	R	V	;								
Answer	1	2	3	4	5	6	7	8	9	10	
	R	V	P1	P2	P2	P2	P2	P2	P2	;	

RX	Sets the transceiver in RX mode										Parameters: P1: always '0'
	See also TX command										
Set	1	2	3	4	5	6	7	8	9	10	
	R	X	;								
Read											
Answer	1	2	3	4	5	6	7	8	9	10	
	R	X	P1	;							

SA	Reads or sets the Tune Snap status										Parameters: P1: snap status '0': OFF '1': ON
Set	1	2	3	4	5	6	7	8	9	10	
	S	A	P1	;							
Read	1	2	3	4	5	6	7	8	9	10	
	S	A	;								
Answer	1	2	3	4	5	6	7	8	9	10	
	S	A	P1	;							

SE	Reads or sets the service mode status										Parameters: P1: always '1', force the service mode P2: always '0', if in service mode this CAT protocol is not available
	Set not available during transmission										
Set	1	2	3	4	5	6	7	8	9	10	
	S	E	P1	;							
Read	1	2	3	4	5	6	7	8	9	10	
	S	E	;								
Answer	1	2	3	4	5	6	7	8	9	10	
	S	E	P2	;							

SI	Sets or reads the selected VFO step index										Parameters: P1: step index Steps list (in Hz): 1, 5, 10, 25, 50, 100, 250, 500, 1000, 2000, 3000, 4500, 5000, 7500, 9000, 10k, 12.5k, 25k, 50k, 100k, 125k, 250k, 500k, 1M.
Set	1	2	3	4	5	6	7	8	9	10	
	S	I	P1	;							
Read	1	2	3	4	5	6	7	8	9	10	
	S	I	;								
Answer	1	2	3	4	5	6	7	8	9	10	
	S	I	P1	;							

SF	Reads or sets the SPF-08 board settings										Parameters: P0: operation type 'F' : saves the filter settings with parameters P2 to P5 'N' : disables the SPF-08 management (P2 to P5 are not treated) 'Y' : enables the SPF-08 management(P2 to P5 are not treated) P1: SPF-08 management status 'N' : management disabled 'Y' : management enabled P2 : filter index, '0' ~ '7' P3 : filter usage status, '0' : not used '1' : used P4 filter low frequency P5 filter high frequency
Set	1	2	3	4	5	6	7	8	9	10	
	S	F	P0	P2	P3	P4	P4	P4	P4	P4	
	11	12	13	14	15	16	17	18	19	20	
	P4	P4	P4	P4	P4	P4	P5	P5	P5	P5	
Read	21	22	23	24	25	26	27	28			
	P5	P5	P5	P5	P5	P5	P5	;			
Answer	1	2	3	4	5	6	7	8	9	10	
	S	F	P1	P2	P3	P4	P4	P4	P4	P4	
	11	12	13	14	15	16	17	18	19	20	
	P4	P4	P4	P4	P4	P4	P5	P5	P5	P5	
Read	21	22	23	24	25	26	27	28			
	P5	P5	P5	P5	P5	P5	P5	;			

SM	Reads the S-meter status										Parameters: P1: always '0' P2: Meter Read "0000": S0 "0002": S1 "0003": S2 "0004": S3 "0005": S4 "0006": S5 "0008": S6 "0009": S7 "0010": S8 "0011": S9 "0012": S9+10 "0014": S9+20 "0016": S9+30 "0018": S9+40 "0020": S9+50 "0022" : S9+60
Set											
Read	1	2	3	4	5	6	7	8	9	10	
	S	M	P1	;							
Answer	1	2	3	4	5	6	7	8	9	10	
	S	M	P1	P2	P2	P2	P2	;			

SN	Reads the transceiver serial number										Parameters: P1 : serial number
Set											
Read	1	2	3	4	5	6	7	8	9	10	
	S	N	;								
Answer	1	2	3	4	5	6	7	8	9	10	
	S	N	P1	P1	P1	P1	P1	P1	P1	P1	
	11	12	13	14	15	16	17	18	19	20	
	P1	P1	P1	P1	P1	P1	;				

SP	Reads or sets the SPLIT state										Parameters: P1 : '0' : SPLIT OFF '1' : REMOTE SPLIT ON '2' : STAND ALONE SPLIT ON
	Set not available during transmission and when MEM mode is activated										
Set	1	2	3	4	5	6	7	8	9	10	
	S	P	P1	;							
Read	1	2	3	4	5	6	7	8	9	10	
	S	P	;								
Answer	1	2	3	4	5	6	7	8	9	10	
	S	P	P1	;							

SQ	Reads or sets the squelch value										Parameters: P1 : always 0 P2 : squelch value: 0: OFF 1-10: ON
Set	1	2	3	4	5	6	7	8	9	10	
	S	Q	P1	P2	P2	P2	;				
Read	1	2	3	4	5	6	7	8	9	10	
	S	Q	P1	;							
Answer	1	2	3	4	5	6	7	8	9	10	
	S	Q	P1	P2	P2	P2	;				

SW	Sends/sets the CW message to send										Parameters: P1 "000" and P2 '0' : stops the CW Message transmission P1 "000" e P2 '1' : starts the CW Message transmission P1 "001 - 010" and P2 '0' : sets the number (1 to 10) of the CW message to send P1 "001 - 010" and P2 '1' : sends the CW Message with number P1 (1 to 10) P3 : the number of the CW Message to send P4 : '1' during the transmission of the CW message, otherwise '0'
	Set available in transmission only if P1 and P2 are 0 See also CM and CP commands										
Set	1	2	3	4	5	6	7	8	9	10	
	S	W	P1	P1	P1	P2	;				
Read	1	2	3	4	5	6	7	8	9	10	
	S	W	;								
Answer	1	2	3	4	5	6	7	8	9	10	
	S	W	P3	P3	P3	P4	;				

TB	Reads or sets the transmission bandwidth										Parameters: P1 : always '0' P2 : see parameter details below
	Set not available during transmission										
Set	1	2	3	4	5	6	7	8	9	10	
	T	B	P1	P2	P2	;					
Read	1	2	3	4	5	6	7	8	9	10	
	T	B	P1	;							
Answer	1	2	3	4	5	6	7	8	9	10	
	T	B	P1	P2	P2	;					

TB command - P2 parameter

P2	LOW FREQUENCY	HIGH FREQUENCY
00	50Hz	4000Hz
01	100Hz	2700Hz
02	100Hz	3000Hz
03	100Hz	3500Hz
04	100Hz	4000Hz
05	200Hz	2700Hz
06	200Hz	3000Hz
07	200Hz	3500Hz
08	200Hz	4000Hz
09	300Hz	2700Hz
10	300Hz	3000Hz
11	300Hz	3500Hz
12	300Hz	4000Hz

TC	Reads or sets the action to do when pressing the microphone PTT while in CW mode										Parameters: P1 : '0' : CW message preparation '1' : PTT OUT output assertion
	Set not available during transmission										
Set	1	2	3	4	5	6	7	8	9	10	
	T	C	P1	;							
Read	1	2	3	4	5	6	7	8	9	10	
	T	C	;								
Answer	1	2	3	4	5	6	7	8	9	10	
	T	C	P1	;							

TE	Reads or sets the transmitter status										Parameters: P1 : '0' : disabled '1' : enabled
	Set not available during transmission										
Set	1	2	3	4	5	6	7	8	9	10	
	T	E	P1	;							
Read	1	2	3	4	5	6	7	8	9	10	
	T	E	;								
Answer	1	2	3	4	5	6	7	8	9	10	
	T	E	P1	;							

TH	Reads or sets the AGC threshold value										Parameters: P1: AGC threshold, from 0 (OFF) to 10	
	See also GC and GS commands											
Set	1	2	3	4	5	6	7	8	9	10		
	T	H	P1	P1	;							
Read	1	2	3	4	5	6	7	8	9	10		
	T	H	;									
Answer	1	2	3	4	5	6	7	8	9	10		
	T	H	P1	P1	;							

TI	Reads or sets the transmission input										Parameters: P1 : '0' : microphone '1' : USB audio '2' : Auto	
	Set not available during transmission											
Set	1	2	3	4	5	6	7	8	9	10		
	T	I	P1	;								
Read	1	2	3	4	5	6	7	8	9	10		
	T	I	;									
Answer	1	2	3	4	5	6	7	8	9	10		
	T	I	P1	;								

TL	Reads or sets the tune transmission power										Parameters: P1 : 0: 0.3W 1: 0.5W 2: 1.0W 3: 1.2W 4: 1.5W 5: 2.0W 6: 3.0W 7: 4.0W 8: 5.0W 9: MAX	
	See also TP and TQ commands											
Set	1	2	3	4	5	6	7	8	9	10		
	T	L	P1	P1	;							
Read	1	2	3	4	5	6	7	8	9	10		
	T	L	;									
Answer	1	2	3	4	5	6	7	8	9	10		
	T	L	P1	P1	;							
	T	P	P1	P1	;							

TP	Reads or sets the transmission power										Parameters: P1 : 0: 0.3W 1: 0.5W 2: 1.0W 3: 1.2W 4: 1.5W 5: 2.0W 6: 3.0W 7: 4.0W 8: 5.0W 9: MAX	
	See also TL and TQ commands											
Set	1	2	3	4	5	6	7	8	9	10		
	T	P	P1	P1	;							
Read	1	2	3	4	5	6	7	8	9	10		
	T	P	;									
Answer	1	2	3	4	5	6	7	8	9	10		
	T	P	P1	P1	;							

TQ	Reads or sets the transmission power in a fine way										Parameters: P1: transmission power in mW, accepted values are 0.1W to 5.0W in 0.1W steps, 0 means MAX
	See also TL and TP commands										
Set	1	2	3	4	5	6	7	8	9	10	
	T	Q	P1	P1	P1	P1	;				
Read	1	2	3	4	5	6	7	8	9	10	
	T	Q	;								
Answer	1	2	3	4	5	6	7	8	9	10	
	T	Q	P1	P1	P1	P1	;				

TR	Reads or sets the activation status of the RTS transmission.										Parameters: P1: '0': OFF '1': ON
	Set not available during transmission										
Set	1	2	3	4	5	6	7	8	9	10	
	T	R	P1	;							
Read	1	2	3	4	5	6	7	8	9	10	
	T	R	;								
Answer	1	2	3	4	5	6	7	8	9	10	
	T	R	P1	;							

TT	Reads or sets the output type for the transmission										Parameters: P1: '0': POWER (RTX ANTENNA) '1': 0dBm (RF OUT)
	Set not available during transmission										
Set	1	2	3	4	5	6	7	8	9	10	
	T	T	P1	;							
Read	1	2	3	4	5	6	7	8	9	10	
	T	T	;								
Answer	1	2	3	4	5	6	7	8	9	10	
	T	T	P1	;							

TU	Reads or sets the time out value of the tune function										Parameters: P1: time out value in seconds: "003" "005" ~ "120" in 5 dots step
	Set not available during transmission										
Set	1	2	3	4	5	6	7	8	9	10	
	T	U	P1	P1	P1	;					
Read	1	2	3	4	5	6	7	8	9	10	
	T	U	;								
Answer	1	2	3	4	5	6	7	8	9	10	
	T	U	P1	P1	P1	;					

TV	Reads or sets the default parameter to be displayed during a transmission										Parameters: P1: '0': frequency '1': forward power '2': reflected power '3': SWR
Set	1	2	3	4	5	6	7	8	9	10	
	T	V	P1	;							
Read	1	2	3	4	5	6	7	8	9	10	
	T	V	;								
Answer	1	2	3	4	5	6	7	8	9	10	
	T	V	P1	;							

TX	Sets the transceiver in TX mode										Parameters: P1: '0' and '1': normal transmission (MIC or USB) '2': tune transmission (CW tone) P2: always '0'
	See also RX command										
Set	1	2	3	4	5	6	7	8	9	10	
	T	X	P1	;							
Read											
Answer	1	2	3	4	5	6	7	8	9	10	
	T	X	P2	;							

UD	Reads or sets the acceleration of the mic up/down buttons										Parameters: P1: from 1 to 3
Set	1	2	3	4	5	6	7	8	9	10	
	U	D	P1	;							
Read	1	2	3	4	5	6	7	8	9	10	
	U	D	;								
Answer	1	2	3	4	5	6	7	8	9	10	
	U	D	P1	;							

UU	Activates the UI update mode										Parameters: P1 : always '1' P2 : "5214" P3 : result: '0' error '1' ok
Set	1	2	3	4	5	6	7	8	9	10	
	U	U	P1	P2	P2	P2	P2	;			
Read											
Answer	1	2	3	4	5	6	7	8	9	10	
	U	U	P3	;							

VA	Reads or sets the auxiliary volume										Parameters: P1: "000" ~ "100"
	See also VM and VT commands										
Set	1	2	3	4	5	6	7	8	9	10	
	V	A	P1	P1	P1	;					
Read	1	2	3	4	5	6	7	8	9	10	
	V	A	;								
Answer	1	2	3	4	5	6	7	8	9	10	
	V	A	P1	P1	P1	;					

VE	Do VFOs equal										Parameters: P1: '1' : set the VFO not active with the parameters of the active VFO and change VFO '2' : set the active VFO with the VFO parameters not active, it does not change VFO P2: always '0'
	Set not available during transmission Set not available if split mode is active Set not available if in MEM mode										
Set	1	2	3	4	5	6	7	8	9	10	
	V	E	P1	;							
Read											
Answer	1	2	3	4	5	6	7	8	9	10	
	V	E	P2	;							

VM	Reads or sets the main volume										Parameters: P1: "000" ~ "015" "020" ~ "100" in 5 dots step
	See also VA and VT commands										
Set	1	2	3	4	5	6	7	8	9	10	
	V	M	P1	P1	P1	;					
Read	1	2	3	4	5	6	7	8	9	10	
	V	M	;								
Answer	1	2	3	4	5	6	7	8	9	10	
	V	M	P1	P1	P1	;					

VS	Reads the FDM-DUO firmware versions										Parameters: P1: firmware identifier character 'I' : User Interface 'F' : FPGA 'U' : USB 'R' : Rx Demodulator 'T' : Tx Modulator P2: firmware version in the format "xx.yy" with : - "xx" major number - "yy" minor number
Set											
Read	1	2	3	4	5	6	7	8	9	10	
	V	S	P1	;							
Answer	1	2	3	4	5	6	7	8	9	10	
	V	S	P1	P2	P2	P2	P2	P2	;		

VT	Reads or sets the sidetone volume										Parameters: P1: "000" ~ "100"
	See also VA and VM commands										
Set	1	2	3	4	5	6	7	8	9	10	
	V	T	P1	P1	P1	;					
Read	1	2	3	4	5	6	7	8	9	10	
	V	T	;								
Answer	1	2	3	4	5	6	7	8	9	10	
	V	T	P1	P1	P1	;					

WR	Reads SWR										Parameters: P1 : usually '0', set to '1' if DUO switches automatically to reception because of a high SWR (it corresponds to HI SWR on the DUO's display) P2 : ' '(blank) o '!' in case of an unreliable SWR value, i.e. : - DUO is in RX mode - DUO is in TX mode with 0dBm - if direct power is less than the minimum value for SWR computation (at present 500mW – could be changed) - if SWR value is not compatible with the command format P3 : integer part of SWR P4 : always '.' P5 : decimal part of SWR
Set											
Read	1	2	3	4	5	6	7	8	9	10	
Answer	W	R	;								
	1	2	3	4	5	6	7	8	9	10	
	W	R	P1	P2	P3	P3	P4	P5	P5	;	

WT	Reads or sets the CW Rx threshold										Parameters: P1: threshold value 0 : auto mode from 1 to 10 : manual values
	See also DE command										
Set	1	2	3	4	5	6	7	8	9	10	
	W	T	P1	P1	;						
Read	1	2	3	4	5	6	7	8	9	10	
	W	T	;								
Answer	1	2	3	4	5	6	7	8	9	10	
	W	T	P1	P1	;						

6.3.3 Compatibility commands

The following commands have no effect on the transceiver, they only ensure the compatibility of the FDM-DUO with Ham Radio Deluxe.

AG											Parameters: P1: Always 0 P2: Always 000
Set	1	2	3	4	5	6	7	8	9	10	
Read	1	2	3	4	5	6	7	8	9	10	
	A	G	P1	;							
Answer	1	2	3	4	5	6	7	8	9	10	
	A	G	P1	P2	P2	P2;					

AI											Parameters: P1: Always 0
Set	1	2	3	4	5	6	7	8	9	10	
Read	1	2	3	4	5	6	7	8	9	10	
	A	I	P1	;							
Answer	1	2	3	4	5	6	7	8	9	10	
	A	I	P1	;							

BC											Parameters: P1: Always 0
Set	1	2	3	4	5	6	7	8	9	10	
Read	1	2	3	4	5	6	7	8	9	10	
	B	C	;								
Answer	1	2	3	4	5	6	7	8	9	10	
	B	C	P1	;							

BY											Parameters: P1: Always 0 P2: Always 0
Set	1	2	3	4	5	6	7	8	9	10	
Read	1	2	3	4	5	6	7	8	9	10	
	B	Y	;								
Answer	1	2	3	4	5	6	7	8	9	10	
	B	Y	P1	P2	;						

CA											Parameters: P1: Always 0
Set	1	2	3	4	5	6	7	8	9	10	
Read	1	2	3	4	5	6	7	8	9	10	
	C	A	;								
Answer	1	2	3	4	5	6	7	8	9	10	
	C	A	P1	;							

CN											Parameters: P1: Always 00
Set	1	2	3	4	5	6	7	8	9	10	
Read	1	2	3	4	5	6	7	8	9	10	
	C	N	;								
Answer	1	2	3	4	5	6	7	8	9	10	
	C	A	P1	P1	;						

CT											Parameters: P1: Always 0
Set	1	2	3	4	5	6	7	8	9	10	
Read	1	2	3	4	5	6	7	8	9	10	
	C	T	;								
Answer	1	2	3	4	5	6	7	8	9	10	
	C	T	P1	;							

DL											Parameters: P1: Always 0 P2: Always 00
Set	1	2	3	4	5	6	7	8	9	10	
Read	1	2	3	4	5	6	7	8	9	10	
	D	L	;								
Answer	1	2	3	4	5	6	7	8	9	10	
	D	L	P1	P2	P2	;					

EX											Parameters: P1: 000 - 060: Menu No. P2: Always 00 P3: Always 0 P4: Always 0 P5: Always 0
Set	1	2	3	4	5	6	7	8	9	10	
Read	1	2	3	4	5	6	7	8	9	10	
	E	X	P1	P1	P1	P2	P2	P3	P4	;	
Answer	1	2	3	4	5	6	7	8	9	10	
	E	X	P1	P1	P1	P2	P2	P3	P4	P5	
	11	12	13	14	15	16	17	18	19	20	
	P5	;									

FS											Parameters: P1 Always 0
Set	1	2	3	4	5	6	7	8	9	10	
Read	1	2	3	4	5	6	7	8	9	10	
	F	S	;								
Answer	1	2	3	4	5	6	7	8	9	10	
	F	S	P1	;							

FW											Parameters: P1 Always 0000
Set	1	2	3	4	5	6	7	8	9	10	
Read	1	2	3	4	5	6	7	8	9	10	
	F	W	;								
Answer	1	2	3	4	5	6	7	8	9	10	
	F	W	P1	P1	P1	P1	;				

GT											Parameters: P1 Always 000
Set	1	2	3	4	5	6	7	8	9	10	
Read	1	2	3	4	5	6	7	8	9	10	
	G	T	;								
Answer	1	2	3	4	5	6	7	8	9	10	
	G	T	P1	P1	P1	;					

ID											Parameters: P1: 020
Set	1	2	3	4	5	6	7	8	9	10	
Read	1	2	3	4	5	6	7	8	9	10	
	I	D	;								
Answer	1	2	3	4	5	6	7	8	9	10	
	I	D	P1	P1	P1	;					

IS											Parameters: P1: "+" P2: Always 0000
Set	1	2	3	4	5	6	7	8	9	10	
Read	1	2	3	4	5	6	7	8	9	10	
	I	S	;								
Answer	1	2	3	4	5	6	7	8	9	10	
	I	S	P1	P2	P2	P2	P2	;			

KS											Parameters: P1: 010
Set	1	2	3	4	5	6	7	8	9	10	
Read	1	2	3	4	5	6	7	8	9	10	
	K	S	;								
Answer	1	2	3	4	5	6	7	8	9	10	
	K	S	P1	P1	P1	;					

MF											Parameters: P1: Always 0
Set	1	2	3	4	5	6	7	8	9	10	
Read	1	2	3	4	5	6	7	8	9	10	
	M	F	;								
Answer	1	2	3	4	5	6	7	8	9	10	
	M	F	P1	;							

NL											Parameters: P1: Always 000
Set	1	2	3	4	5	6	7	8	9	10	
Read	1	2	3	4	5	6	7	8	9	10	
	N	L	;								
Answer	1	2	3	4	5	6	7	8	9	10	
	N	L	P1	P1	P1	;					

PA											Parameters: P1: Always 0 P2: Always 0
Set	1	2	3	4	5	6	7	8	9	10	
Read	1	2	3	4	5	6	7	8	9	10	
	P	A	;								
Answer	1	2	3	4	5	6	7	8	9	10	
	P	A	P1	P2	;						

PC											Parameters: P1: Always 005
Set	1	2	3	4	5	6	7	8	9	10	
Read	1	2	3	4	5	6	7	8	9	10	
	P	C	;								
Answer	1	2	3	4	5	6	7	8	9	10	
	P	C	P1	P1	P1	;					

PR											Parameters: P1: Always 0
Set	1	2	3	4	5	6	7	8	9	10	
Read	1	2	3	4	5	6	7	8	9	10	
	P	R	;								
Answer	1	2	3	4	5	6	7	8	9	10	
	P	R	P1	;							

PS											Parameters: P1: Always 1
Set	1	2	3	4	5	6	7	8	9	10	
Read	1	2	3	4	5	6	7	8	9	10	
	P	S	;								
Answer	1	2	3	4	5	6	7	8	9	10	
	P	S	P1	;							

QR											Parameters: P1: Always 0 P2: Always 0
Set	1	2	3	4	5	6	7	8	9	10	
Read	1	2	3	4	5	6	7	8	9	10	
	Q	R	;								
Answer	1	2	3	4	5	6	7	8	9	10	
	Q	R	P1	P2	;						

RG											Parameters: P1: Always 000
Set	1	2	3	4	5	6	7	8	9	10	
Read	1	2	3	4	5	6	7	8	9	10	
	R	G	;								
Answer	1	2	3	4	5	6	7	8	9	10	
	R	G	P1	P1	P1	;					

RL											Parameters: P1: Always 00
Set	1	2	3	4	5	6	7	8	9	10	
Read	1	2	3	4	5	6	7	8	9	10	
	R	L	;								
Answer	1	2	3	4	5	6	7	8	9	10	
	R	L	P1	P1	;						

RM											Parameters: P1: Always 1 P2: Always 0001
Set	1	2	3	4	5	6	7	8	9	10	
Read	1	2	3	4	5	6	7	8	9	10	
	R	M	;								
Answer	1	2	3	4	5	6	7	8	9	10	
	R	M	P1	P2	P2	P2	P2	;			

SD											Parameters: P1: Always 0000
Set	1	2	3	4	5	6	7	8	9	10	
Read	1	2	3	4	5	6	7	8	9	10	
	S	D	;								
Answer	1	2	3	4	5	6	7	8	9	10	
	S	D	P1	P1	P1	P1	;				

SH											Parameters: P1: Always 00
Set	1	2	3	4	5	6	7	8	9	10	
Read	1	2	3	4	5	6	7	8	9	10	
	S	H	;								
Answer	1	2	3	4	5	6	7	8	9	10	
	S	H	P1	P1	;						

SL											Parameters: P1: Always 00
Set	1	2	3	4	5	6	7	8	9	10	
Read	1	2	3	4	5	6	7	8	9	10	
	S	H	;								
Answer	1	2	3	4	5	6	7	8	9	10	
	S	H	P1	P1	;						

TN											Parameters: P1: Always 00
Set	1	2	3	4	5	6	7	8	9	10	
Read	1	2	3	4	5	6	7	8	9	10	
	T	N	;								
Answer	1	2	3	4	5	6	7	8	9	10	
	T	N	P1	P1	;						

TO											Parameters: P1: Always 0
Set	1	2	3	4	5	6	7	8	9	10	
Read	1	2	3	4	5	6	7	8	9	10	
	T	O	;								
Answer	1	2	3	4	5	6	7	8	9	10	
	T	O	P1	;							

TS											Parameters: P1: Always 0
Set	1	2	3	4	5	6	7	8	9	10	
Read	1	2	3	4	5	6	7	8	9	10	
	T	S	;								
Answer	1	2	3	4	5	6	7	8	9	10	
	T	S	P1	;							

VD											Parameters: P1: Always 0000
Set	1	2	3	4	5	6	7	8	9	10	
Read	1	2	3	4	5	6	7	8	9	10	
	V	D	;								
Answer	1	2	3	4	5	6	7	8	9	10	
	V	D	P1	P1	P1	P1	;				

VG											Parameters: P1: Always 000
Set	1	2	3	4	5	6	7	8	9	10	
Read	1	2	3	4	5	6	7	8	9	10	
	V	G	;								
Answer	1	2	3	4	5	6	7	8	9	10	
	V	G	P1	P1	P1	;					

VX											Parameters: P1: Always 0
Set	1	2	3	4	5	6	7	8	9	10	
Read	1	2	3	4	5	6	7	8	9	10	
	V	X	;								
Answer	1	2	3	4	5	6	7	8	9	10	
	V	X	P1	;							

7 Software & Driver Installation

7.1 Software installation

7.1.1 First-time install in Windows 8 and Windows 7

Double-click the file “setup.exe” in the provided USB stick.

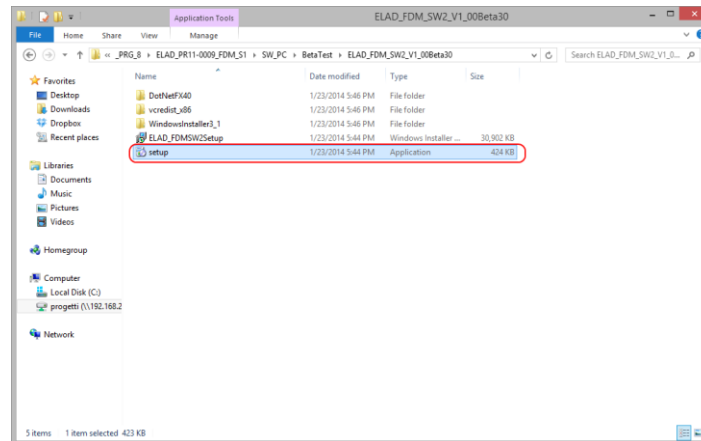

The windows installer first installs the prerequisites:

- Microsoft VC++ 2010 Runtime libraries
 - Microsoft .NET Framework 4.0 (Only for Windows 7)
- and then the FDM-SW2 software.
- Click on “Accept” (Only for Windows 7)

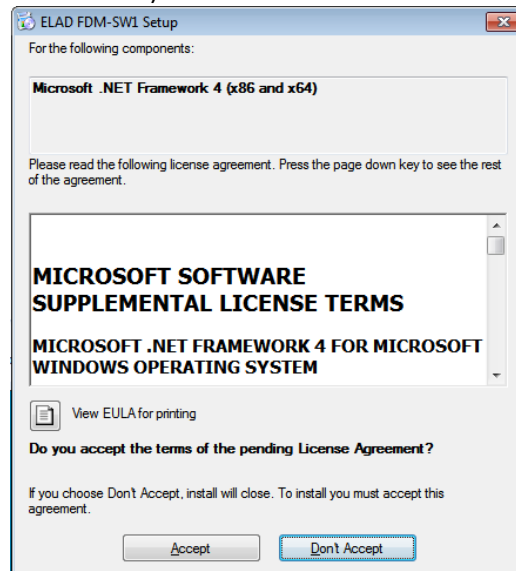

Click on “Install”

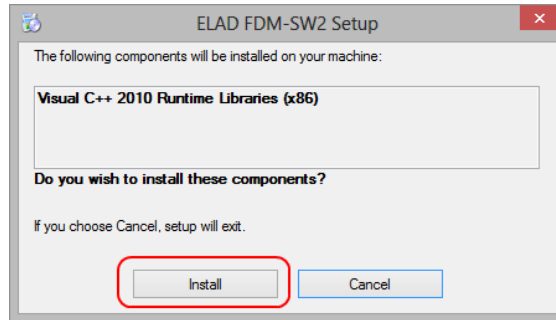

Click on “Yes”

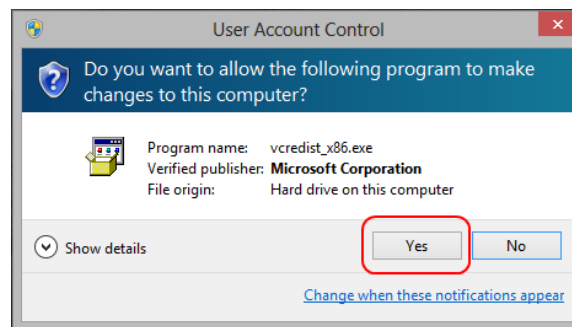

Click on Install

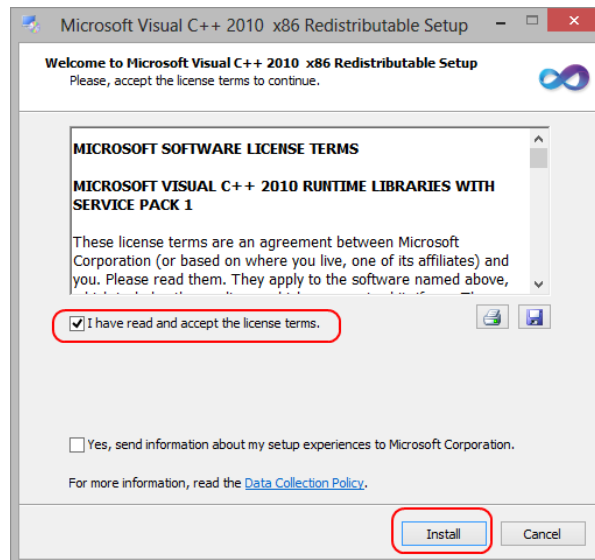

Microsoft Visual C++ 2010 x86 Redistributable installation is complete, click on “Finish”

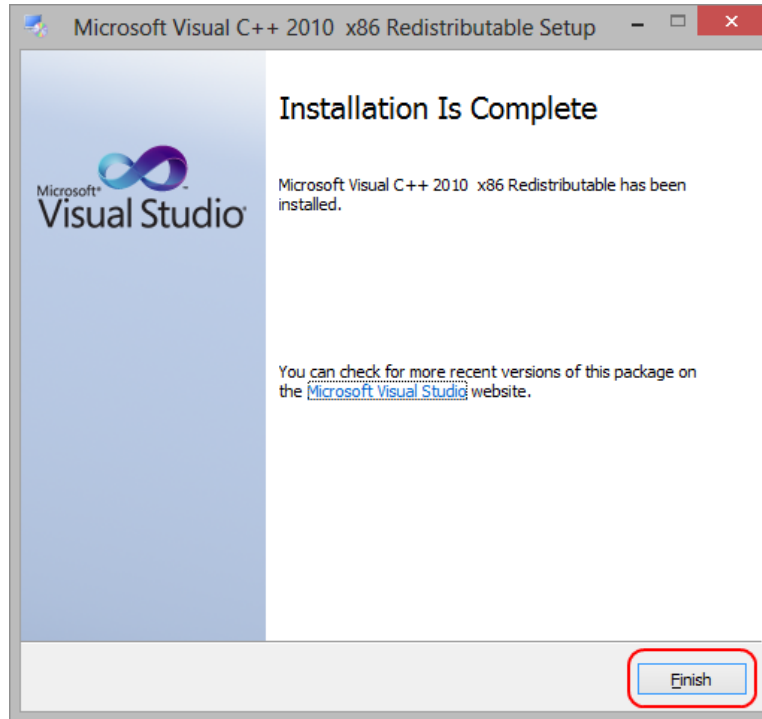

Click on “Yes” to start the installation of the .Net Framework 4.0 (Only for Windows 7)

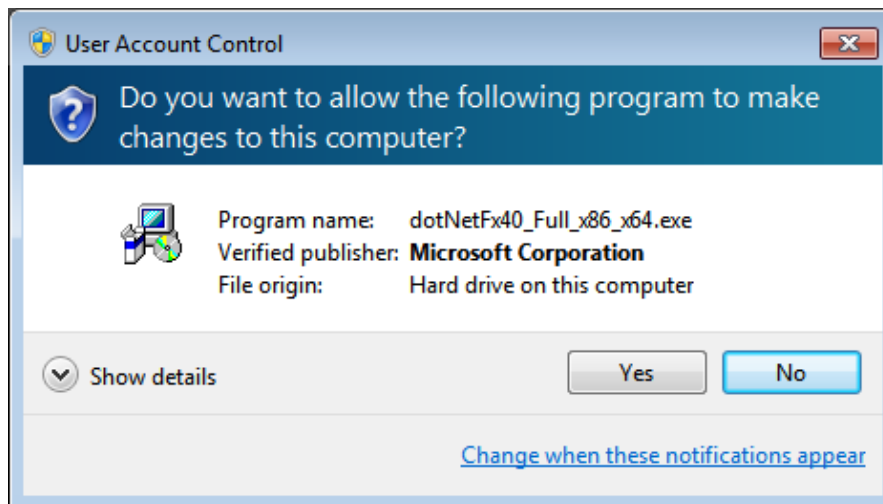

Click to “Next” to start the FDM-SW2 software installation

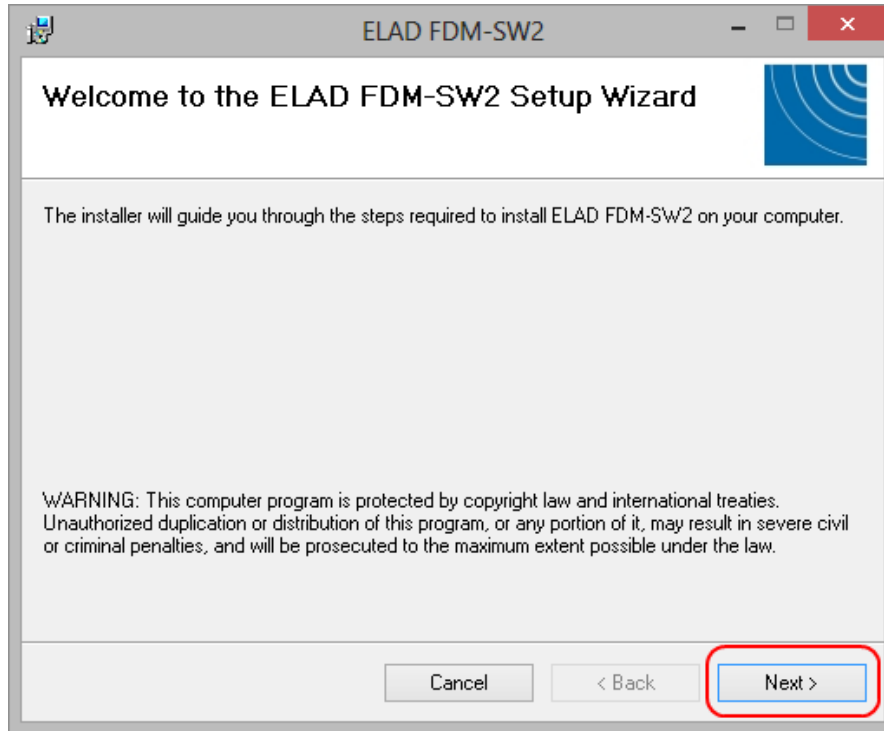

Chose the installation folder, then click on “Next”

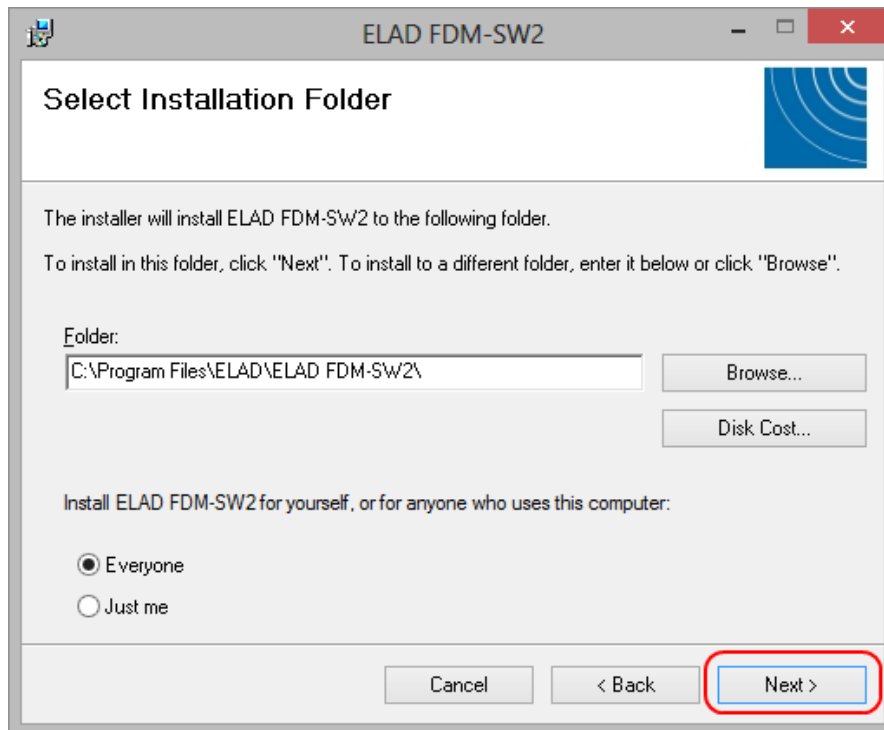

Click on “Next”

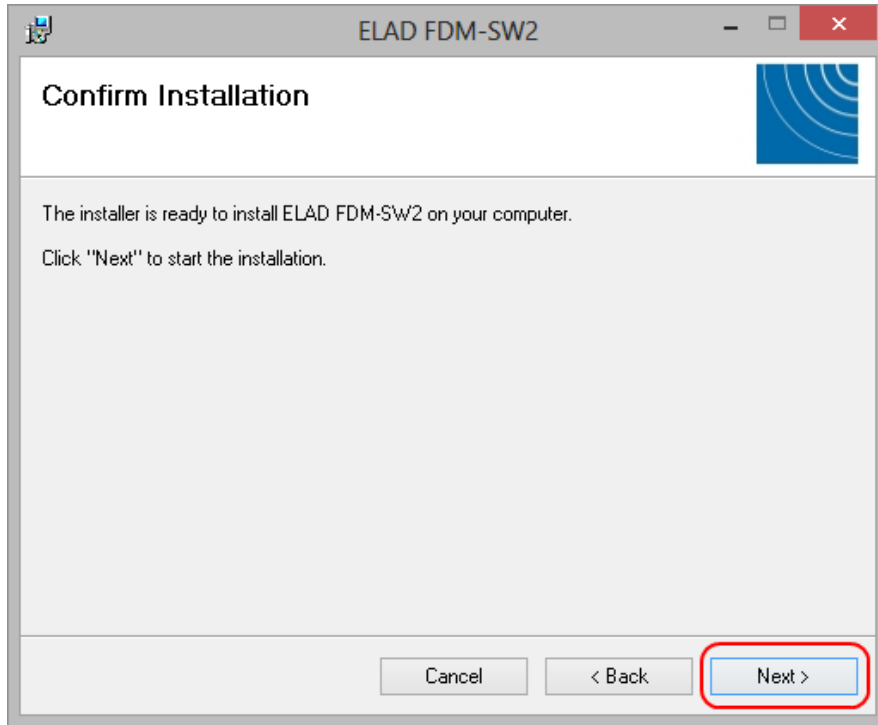

Click on “Yes”

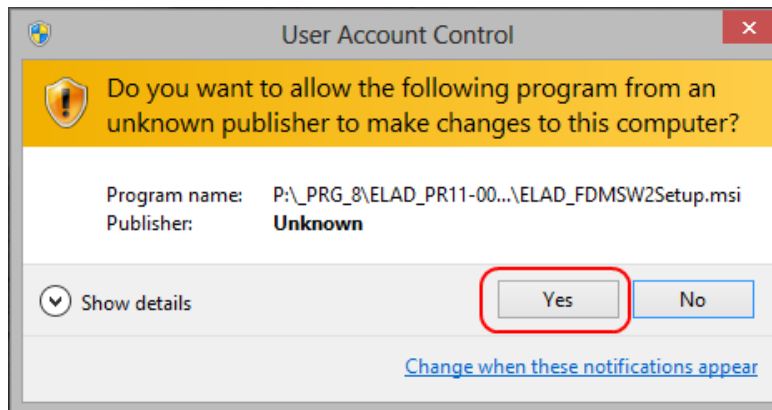

7.1.2 First-time install in Windows XP

Double-click the file “setup.exe” in the provided USB stick.

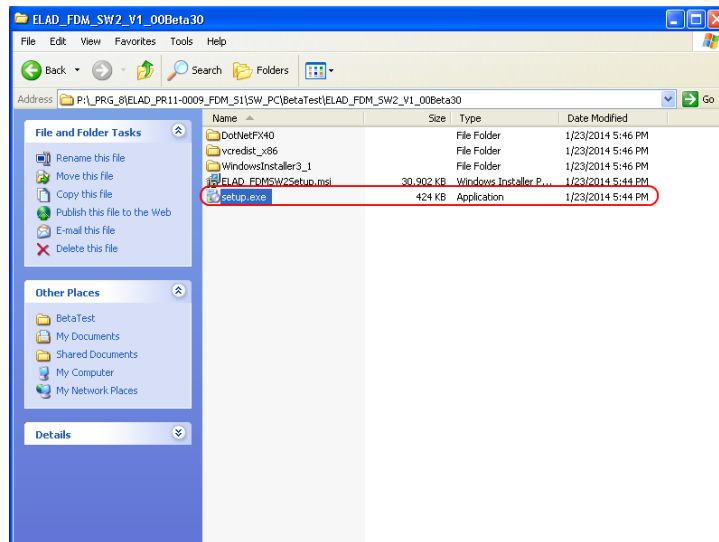

Click on “Accept”

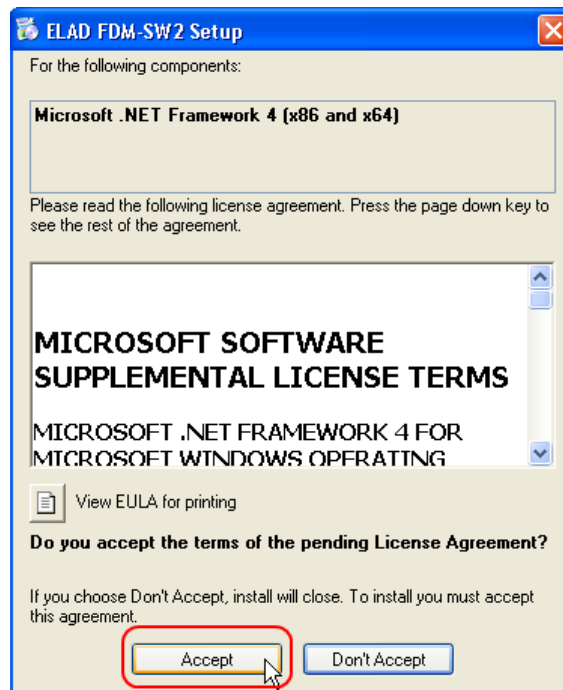

Click on “Install”

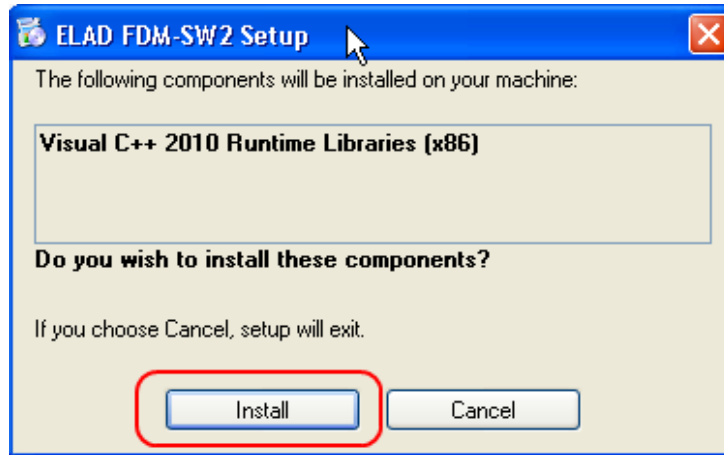

Click on “Install”

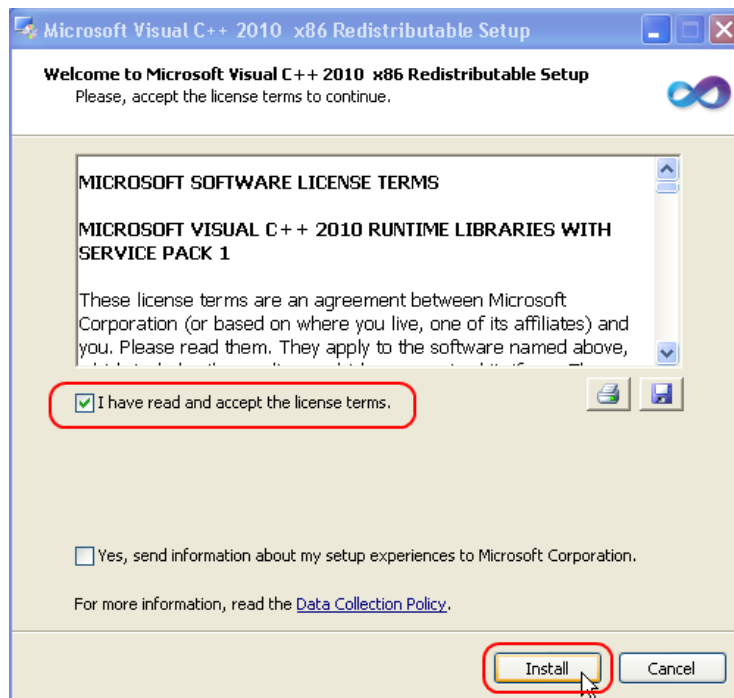

Click on Next to install the FDM-SW2 software

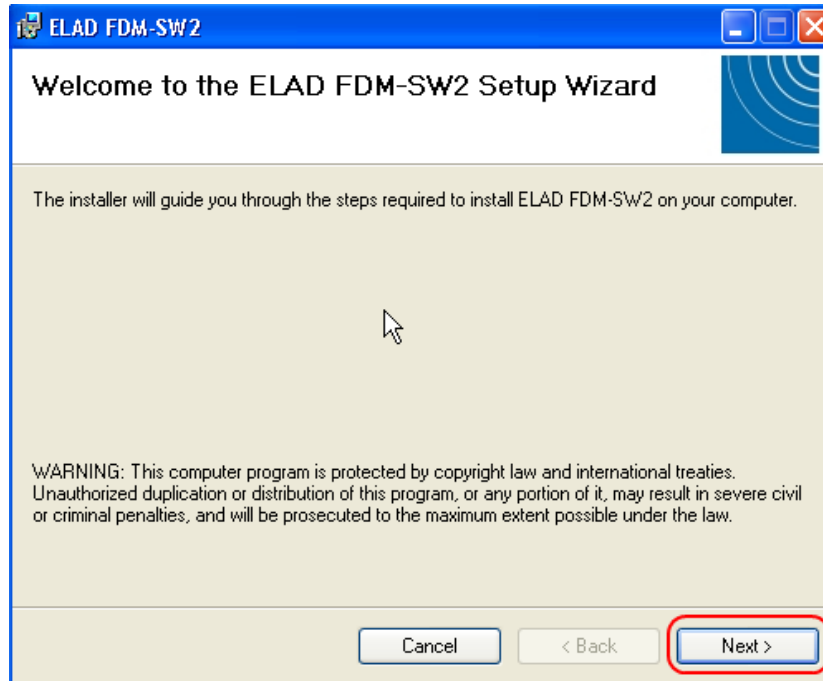

Select the installation folder, then click on "Next"

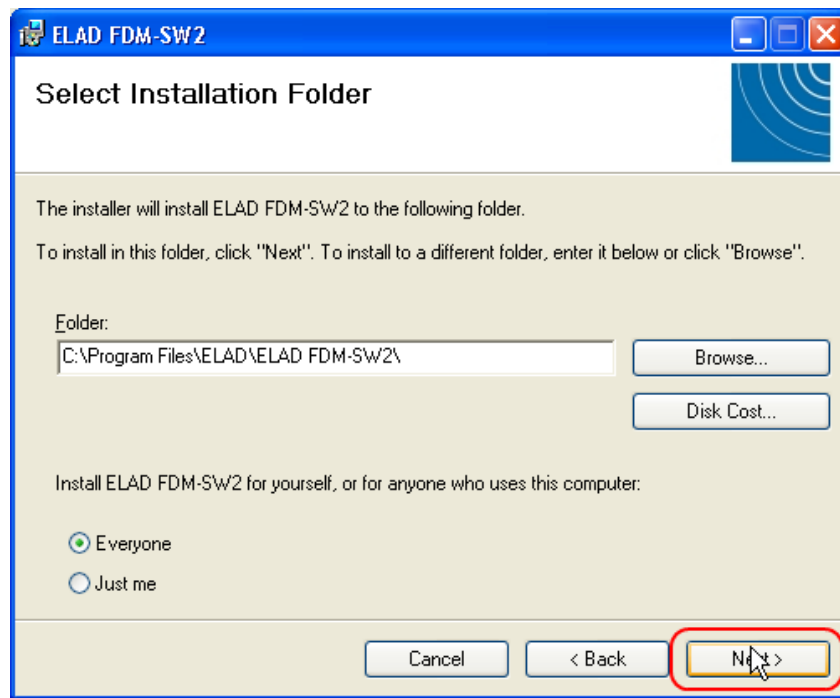

Click on "Next"

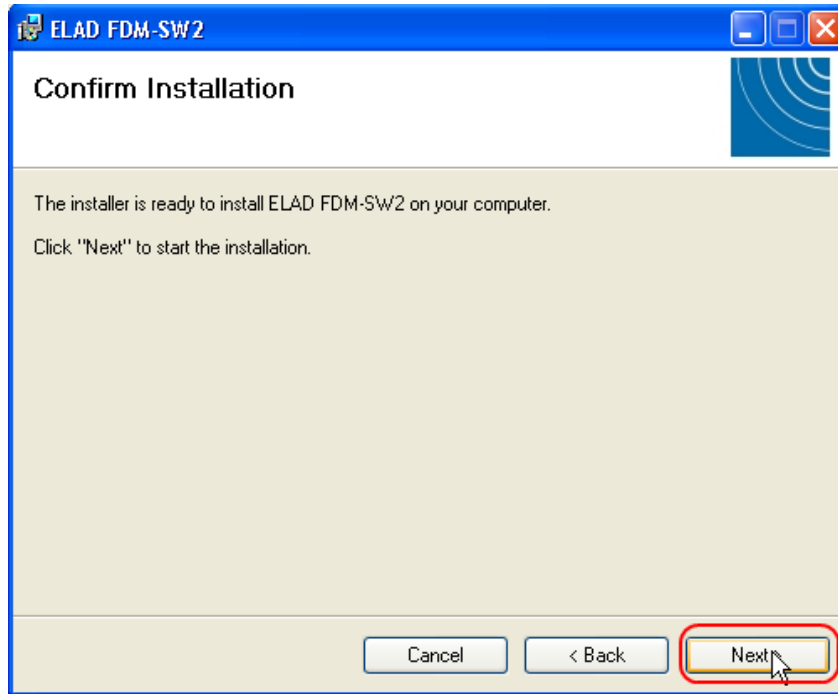

The FDM-SW2 Software installation is completed

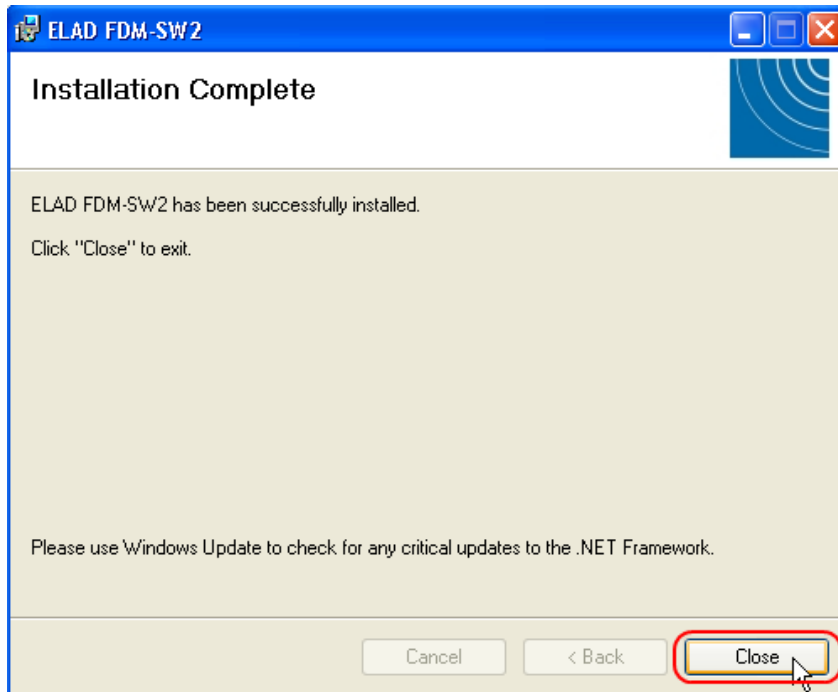

7.1.3 Update an existing software version

Double click on file ELAD_FDM_SW2_V_x.xx.msi included in the update and follow the instructions.

7.2 USB driver

7.2.1 USB driver installation in Windows 8 and Windows 7

7.2.1.1 First driver installation

To install ELAD FDM-DUO driver, connect FDM-DUO USB RX port to a USB 2.0 socket on PC end power on the device. When Windows detects the new hardware, follow the steps listed below to install driver correctly:

Open **Control Panel** from **Start** menu, select “System” and “Device Manager”. Expand “Other Devices” node: FDM-DUO.

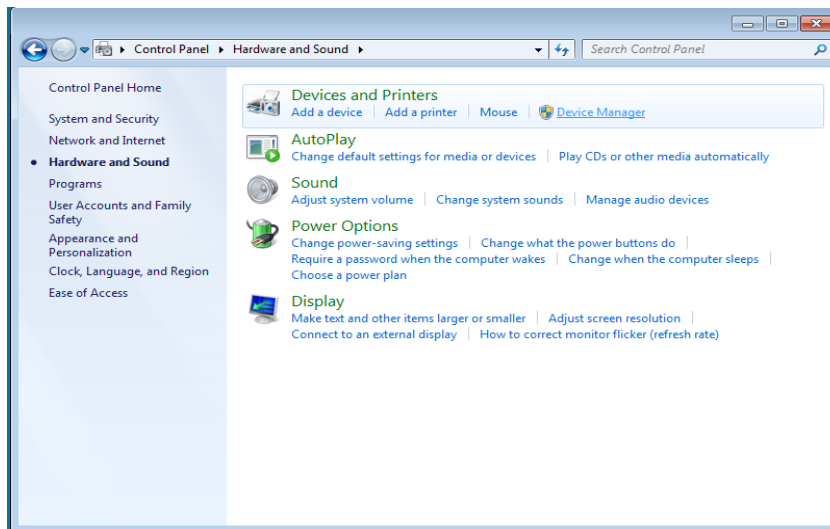

Select FDM-DUO, right click on it and execute “Update driver software”.

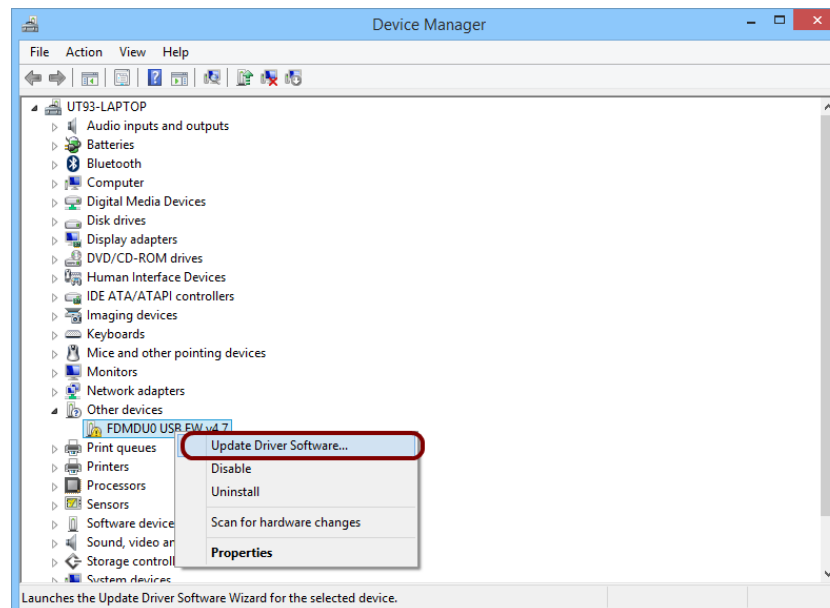

When Windows starts the installation procedure, select the option “Browse my computer for driver software” (the second option).

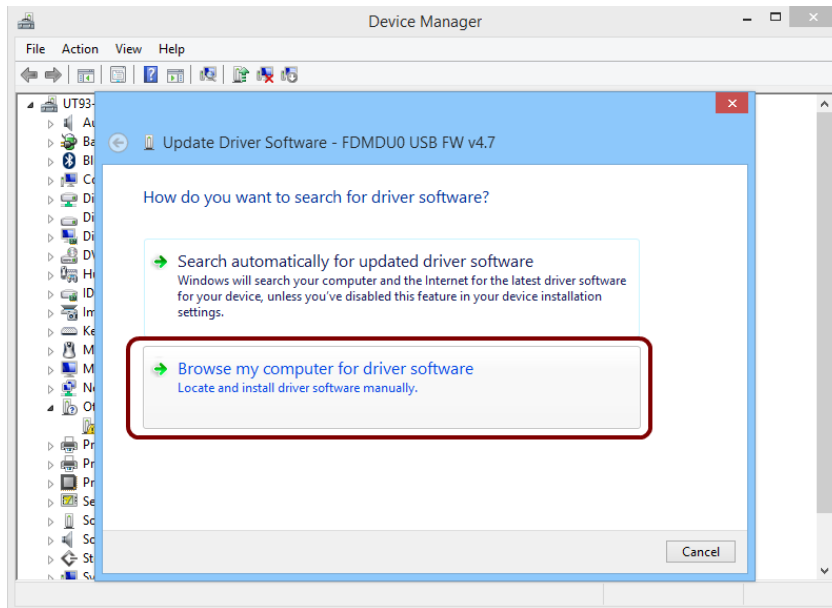

In the next dialog-box, insert the driver folder location using “Browse” button and check the option “Include subfolders”. In this way manual driver search is enabled

For 32 bit system select the folder: **C:\Program Files\ELAD\ELAD FDM-SW2\ELAD_FDM_Driver**
 For 64 bit system select the folder: **C:\Program Files (x86)\ ELAD\ELAD FDM-SW2\ELAD_FDM_Driver**
 Then click “Next”.



Click Install.

Let the hardware installation automatically completes and, at the procedure ending, click on “Close”; then disconnect and connect FDM-DUO device on the same USB socket.

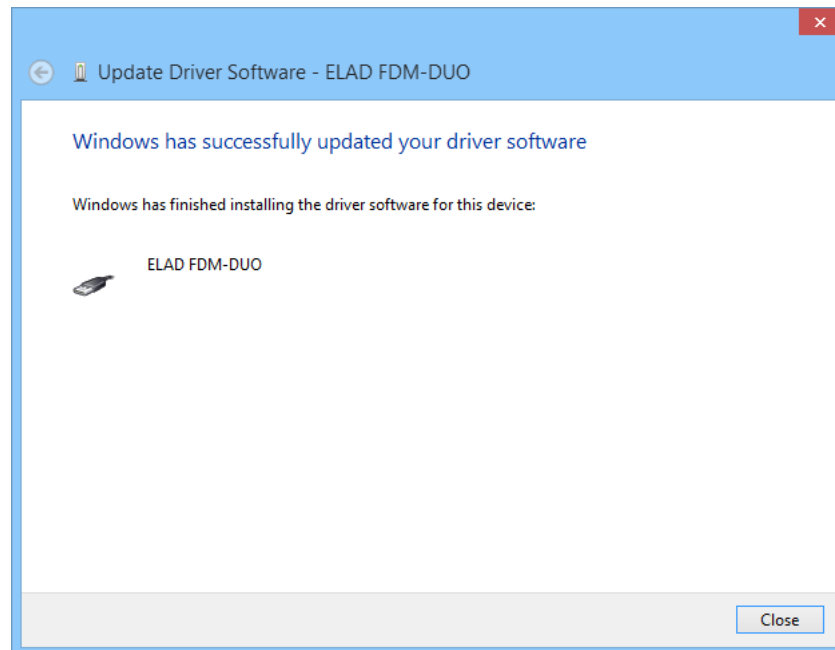

Now ELAD FDM-DUO USB driver is installed on your PC.

7.2.1.2 Driver installation verify

To verify FDM-DUO driver current version, connect the device to USB socket (where the device driver is already installed) and power on the device. Then open **Control Panel** from **Start** menu. Click on “System” and select “Device Manager”.

Expanding “ELAD Samplers” node, right click on “ELAD FDM-DUO” and select “Properties”.

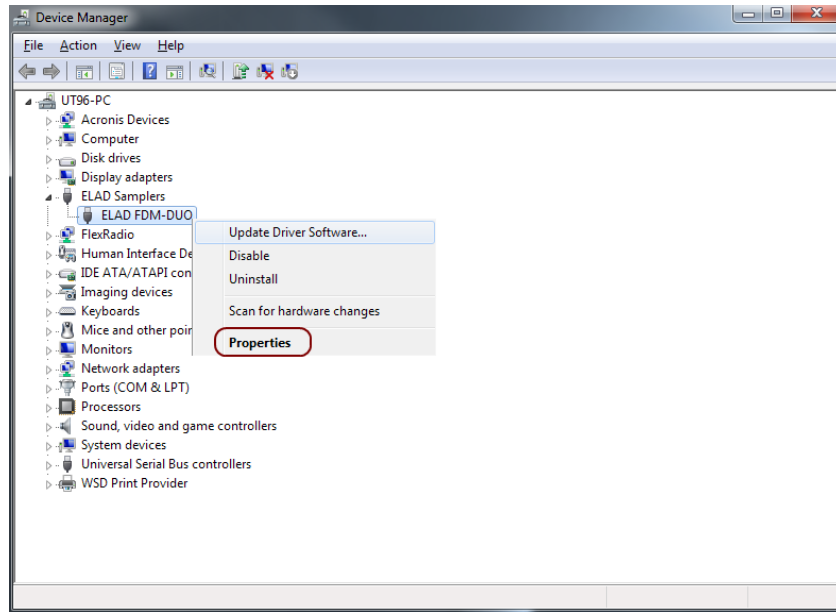

When dialog box opens, select “Driver” label: you must read provider name, current driver release date and current driver version. The figure shows an old FDM- DUO driver version.

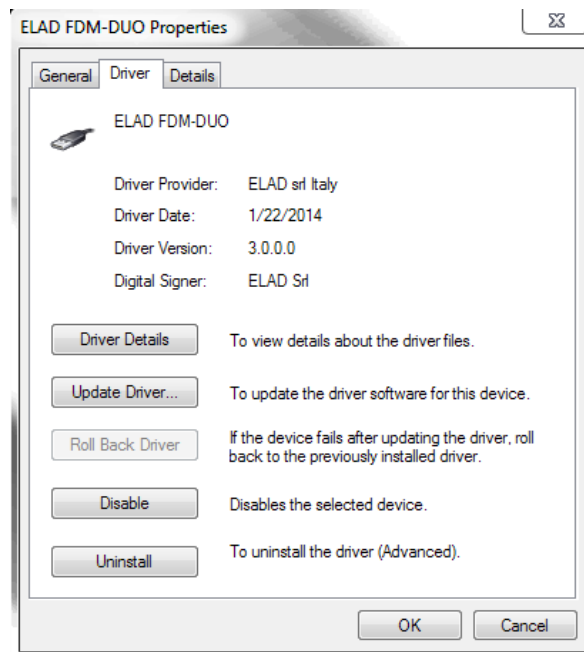

7.2.1.3 Manual driver update

To update FDM-DUO driver, connect the device to USB RX socket (where the device driver is already installed) and power on the device. Then open **Control Panel** from **Start** menu. Click on “System” and select “Device Manager”.

Under “ELAD samplers” list select “ELAD FDM-DUO”, right click on it and execute “Update driver”.

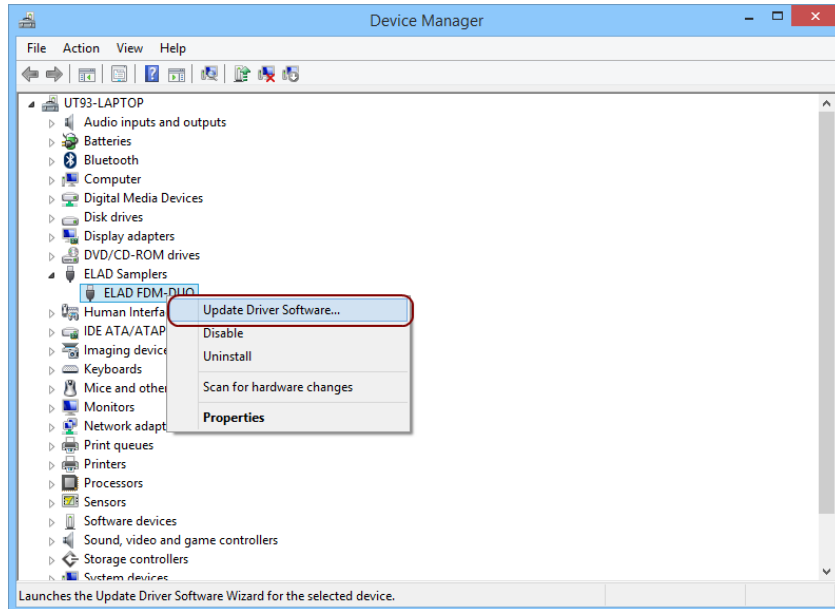

When Windows starts the installation procedure, select the last option “Browse my computer for driver software”.

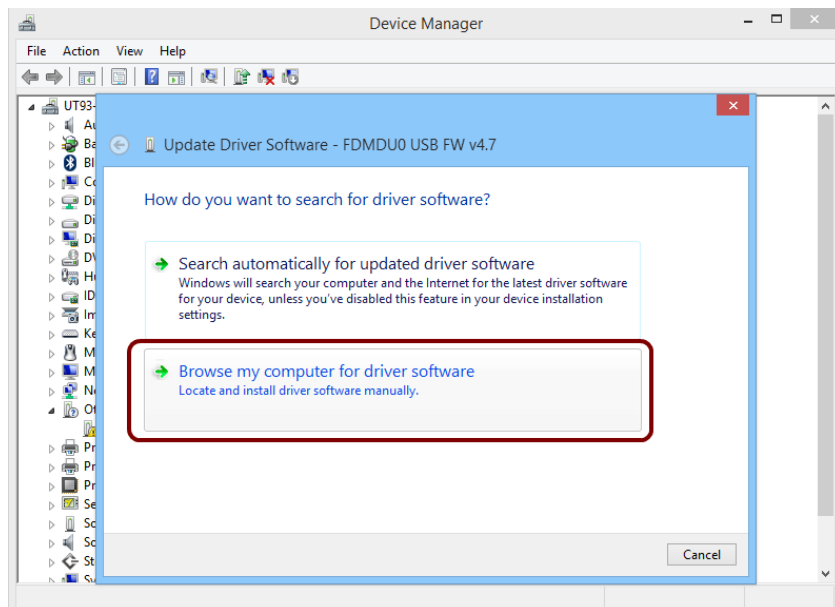

In the next dialog-box, disable the option “Include subfolders” and choose “Let me pick from a list of device drivers on my computer”. Don’t click “Next”.

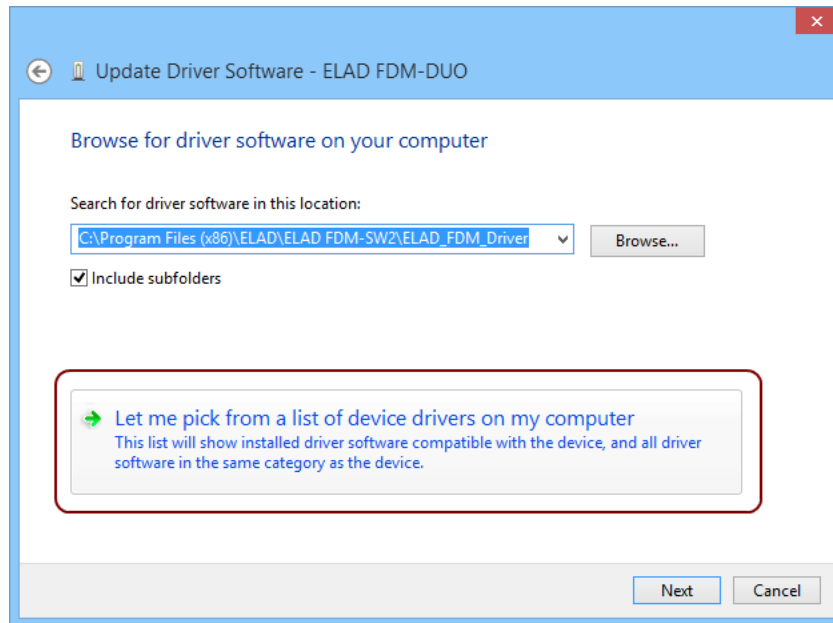

Verify that “Show compatible hardware” option is checked and ELAD FDM-DUO is selected: then click on “Have a Disk”. In this way the manual driver update is enabled. Don’t click “Next”.

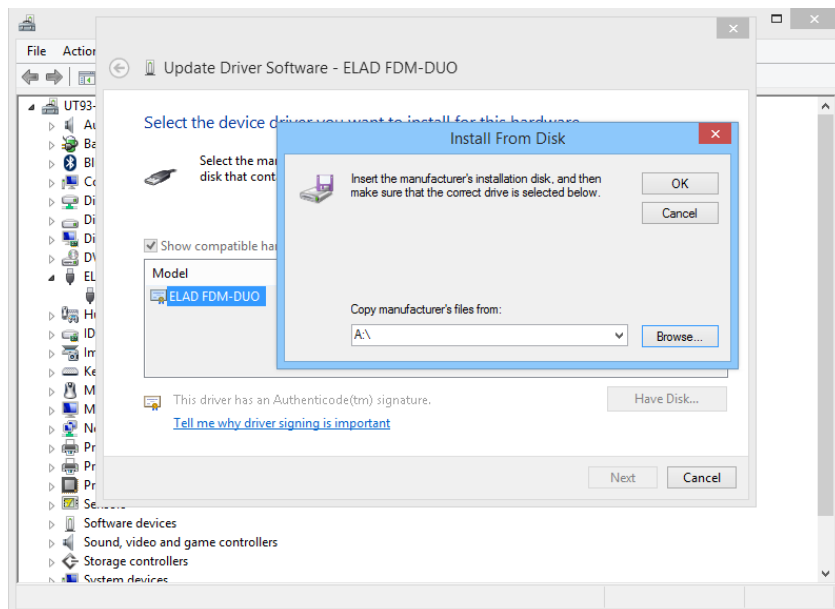

Click on “Browse” and search for FDM-DUO driver update folder location; then open winusb_fdmsampler.inf file. Click “OK” and then “Next”.

Let the hardware installation automatically completes and, at the procedure ending, click on “Close”; then disconnect and connect FDM-DUO device on the same USB socket.

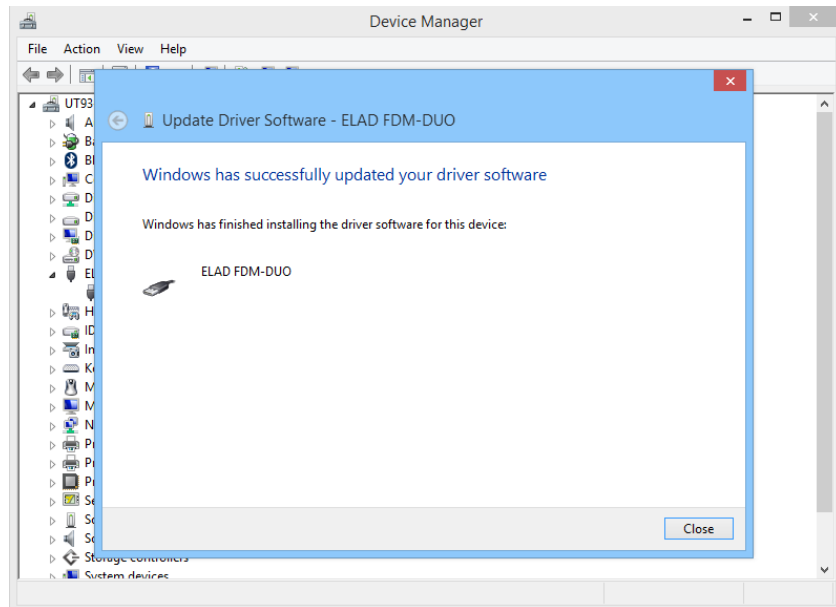

To verify that a correct update is done, enter “Device Manager” in Control Panel; under “ELAD samplers” label select ELAD FDM-DUO driver (see sub-chapter [Driver installation verify in Windows 8 and Windows 7](#)): right click on it and choose “Properties”: select “Driver” label to visualize the last driver version (an example is depicted in figure below).

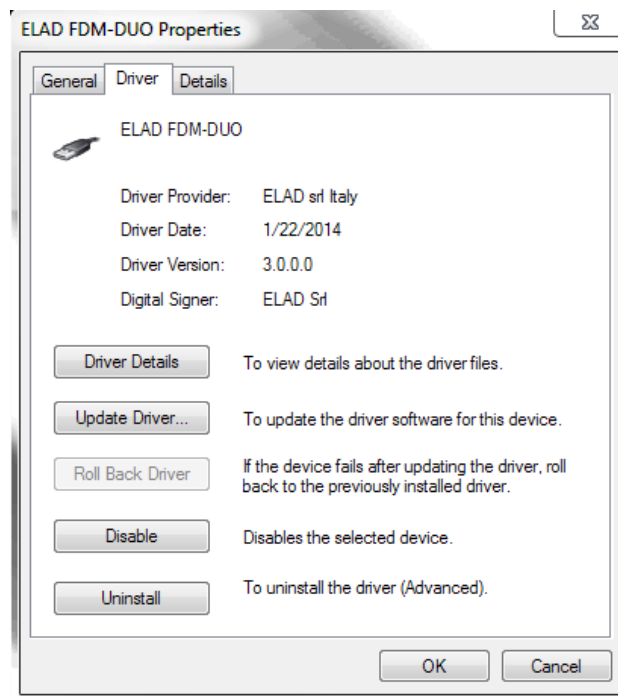

7.2.2 USB driver installation in Windows XP

7.2.2.1 First driver installation

To install ELAD FDM-DUO driver, connect FDM-DUO USB RX port to a USB 2.0 socket on PC and power on the device. Windows XP detects the new hardware and starts the hardware installation wizard. Then, next steps to install FDM-DUO driver are listed below:

At the first dialog box, select the last option “No, not this time” and “Next”.



Select “Install from a list or specific location (Advanced)” and “Next”.

In the next dialog-box, check the options “Search for the best driver in these location” and “Include this location in the search” to enable manual driver search. Clicking on “Browse”, select the path where the driver folder is located: **Local Drive (C:) \Programs\ELAD\ELAD FDM-SW2\ELAD_FDM_Driver**. Then click “Next”.

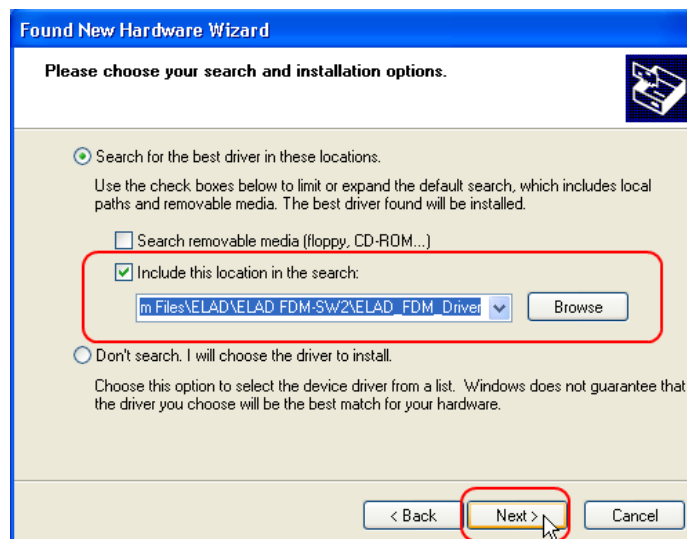

Let the hardware installation automatically completes and click on “Finish”; then disconnect and connect FDM- DUO device on the same USB socket.



Now ELAD FDM- DUO driver is installed on your PC.

7.2.2.2 Driver installation verify

To verify FDM-DUO driver current version, connect the device to USB socket (where the device driver is already installed) and open **Control Panel** from **Start** menu. Click on “System” and select “Device Manager” under “Hardware” label.

Expanding “ELAD Samplers” node, right click on “ELAD FDM-DUO” and select “Properties”.

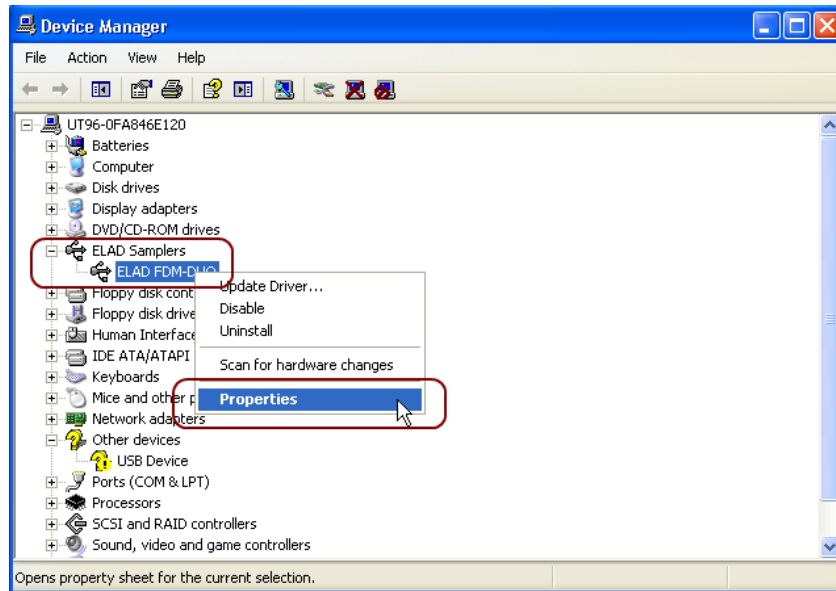

When dialog box opens, select “Driver” label: you must read provider name, current driver release date and current driver version. The old ELAD FDM-DUO driver version is shown in figure below as example.

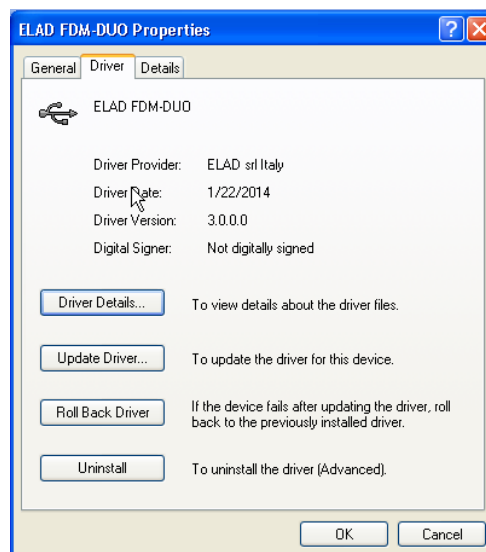

7.2.2.3 Manual driver update

To update FDM-DUO driver, connect the device to USB socket (where the device driver is already installed) and power on the device. Then open **Control Panel** from **Start** menu. Click on “System” and select “Device Manager” under “Hardware” label.

Select “ELAD FDM-DUO” from “ELAD Samplers” list, right click on it and execute “Update driver ”

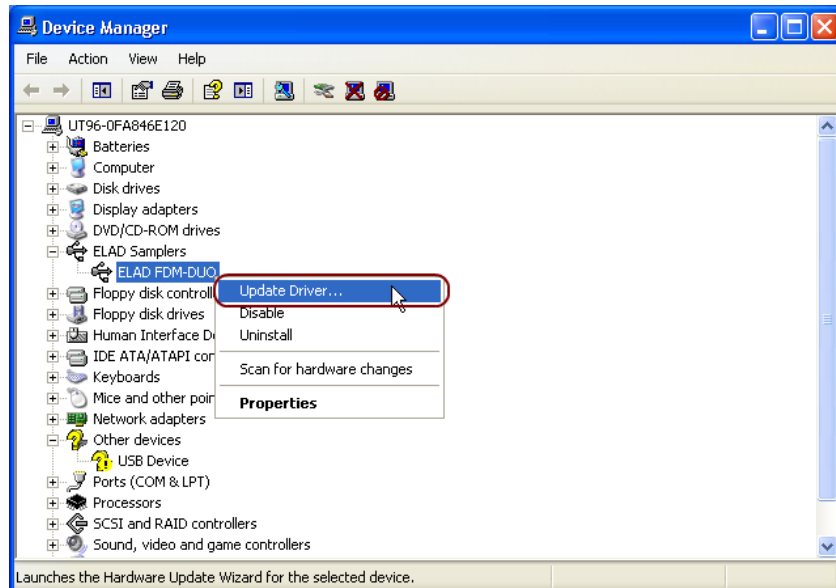

Now Windows XP launches the hardware update wizard: select the last option “No, not this time” and “Next”.

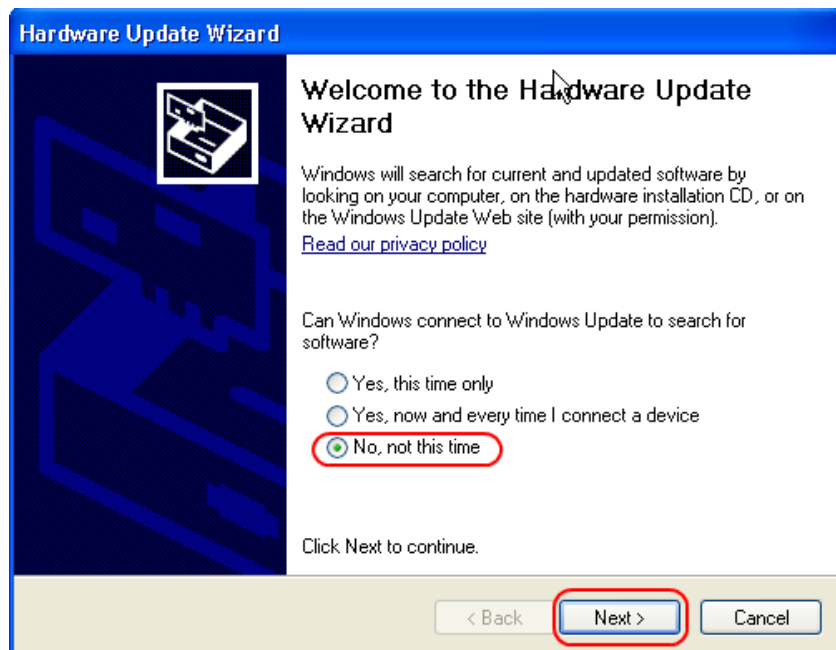

At next step select “Install from a list or specific location (Advanced)” and “Next”.

Then, disable all check-boxes that the system automatically sets and choose the last option for manual driver update, as depicted in figure. Select “Next”.

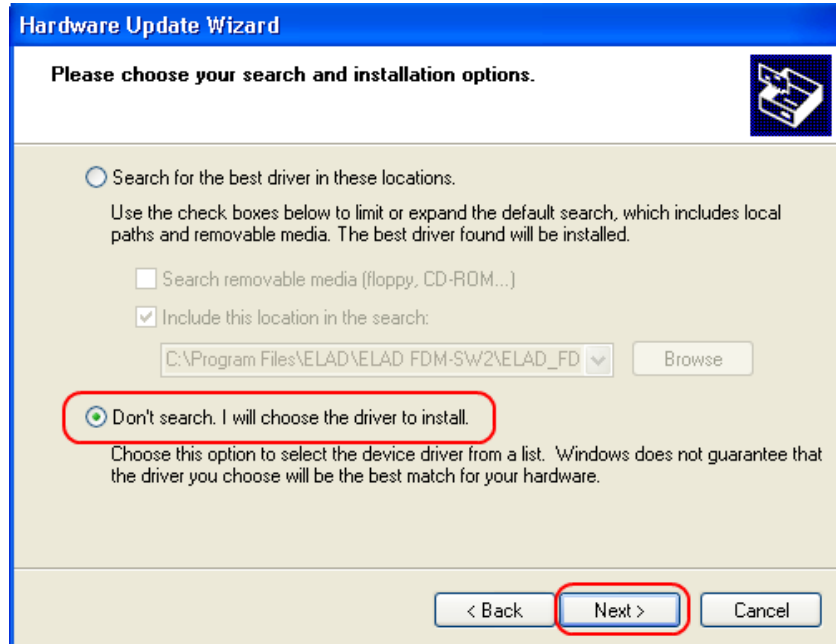

Verify that “Show compatible hardware” option is checked and ELAD FDM-DUO is selected: then click on “Have a Disk”. Don’t click “Next”.

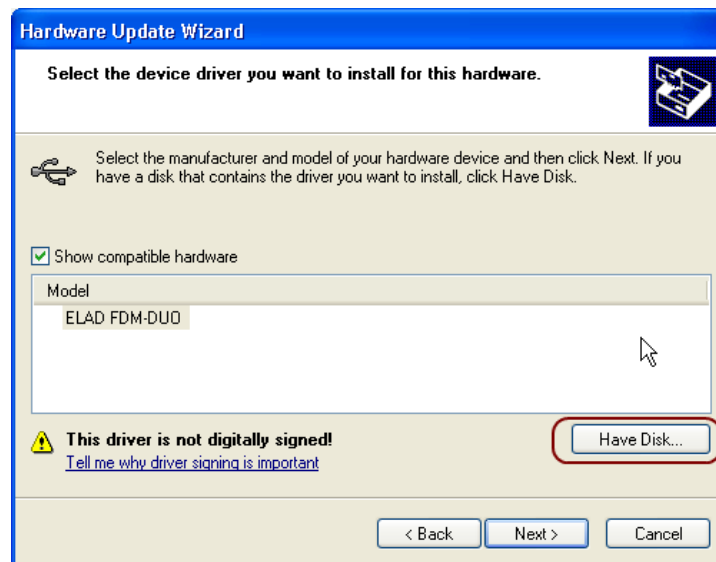

Click on “Browse” and search for the FDM-DUO driver update folder location; then open `winusb_fdmsampler.inf` file, as depicted in figure. Click “OK” and then “Next”.

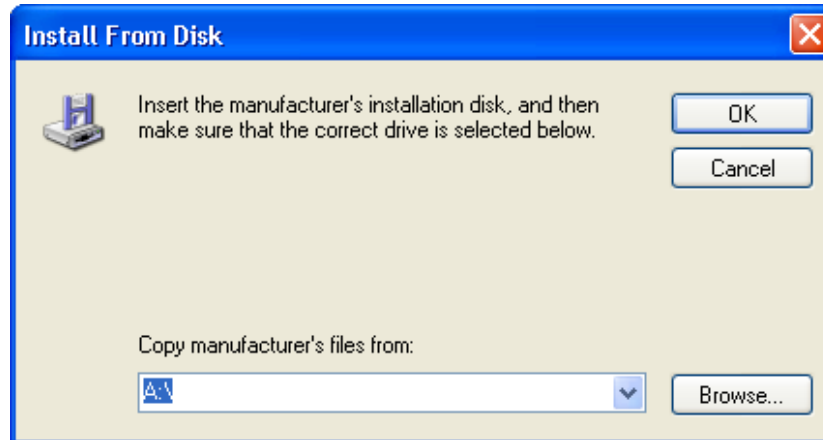

Now driver update starts: at next dialog box select “Continue Anyway” and ignore the warning.

Let the hardware update automatically completes and, at the procedure ending, click on “Finish”; then disconnect e connect FDM-DUO device on the same USB socket.

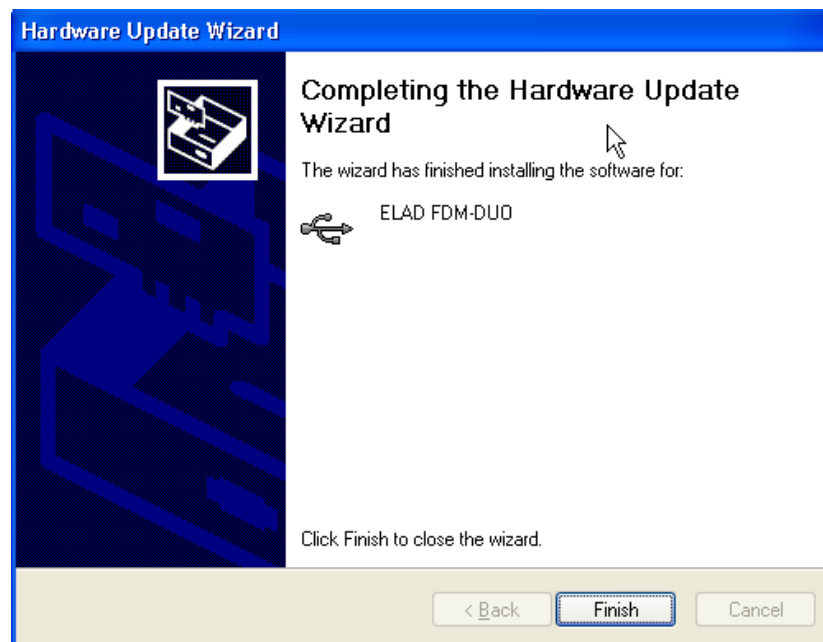

To verify that a correct update is done, enter “Device Manager” from **Control Panel**; under “ELAD Samplers” list, select ELAD FDM-DUO driver (see chapter [Driver installation verify in Windows Xp](#)) right click on it and choose “Properties”. Select “Driver” label to visualize the last driver version (an example is depicted in figure below).

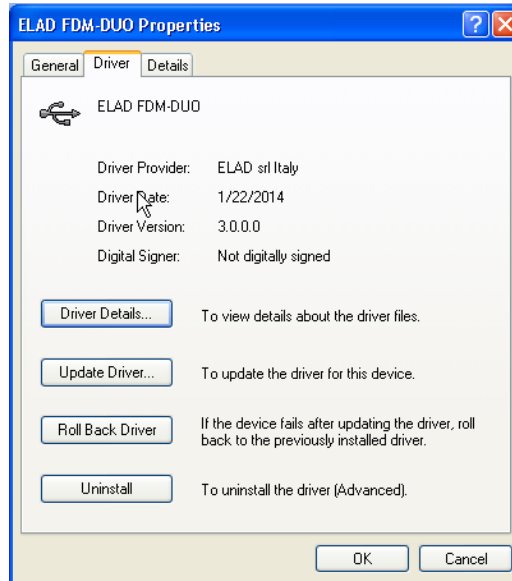

7.2.3 USB sound card

Connect the TX USB port of FDM-DUO to a USB 2.0 port of the PC and power on the device. Then open the PC device manager. No driver installation is required for this device, just expand the node Audio inputs and outputs and check the FDM-DUO audio device.

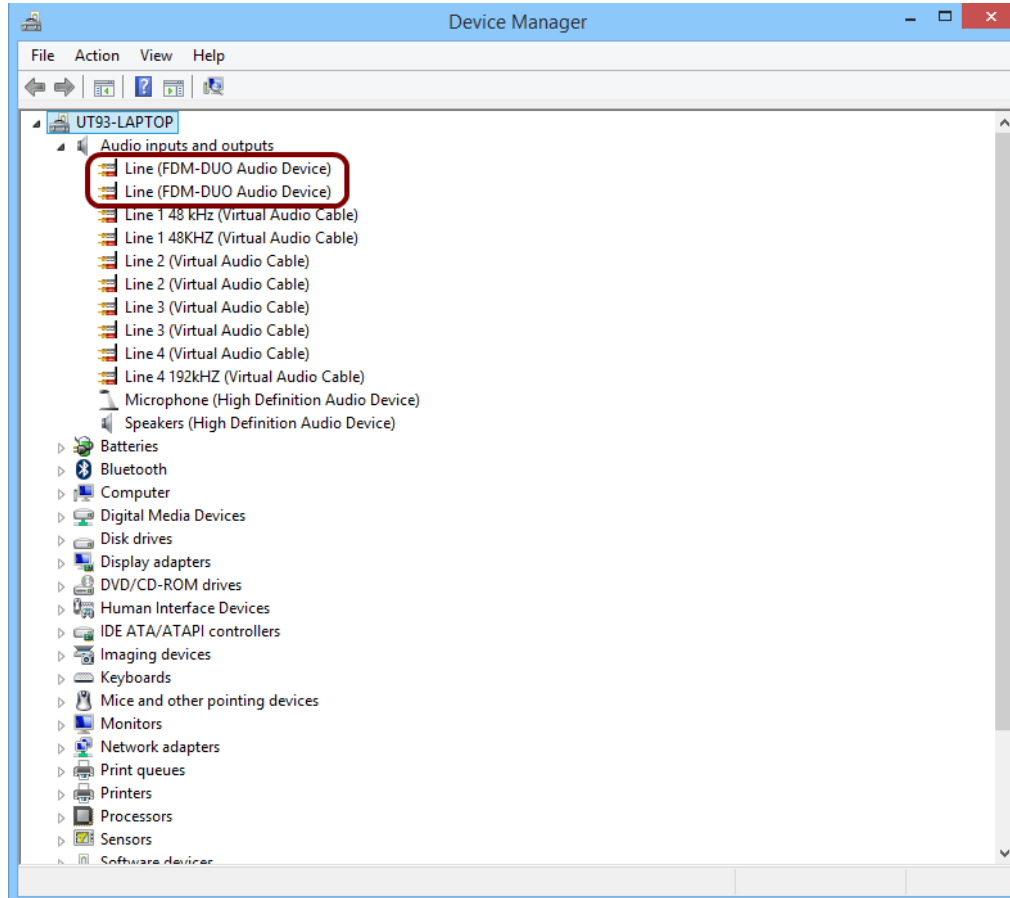

7.2.4 USB CAT Serial port

Connect the CAT USB port of FDM-DUO to a USB 2.0 port of the PC . Windows download and install automatically the FTDI FT232R serial port driver.

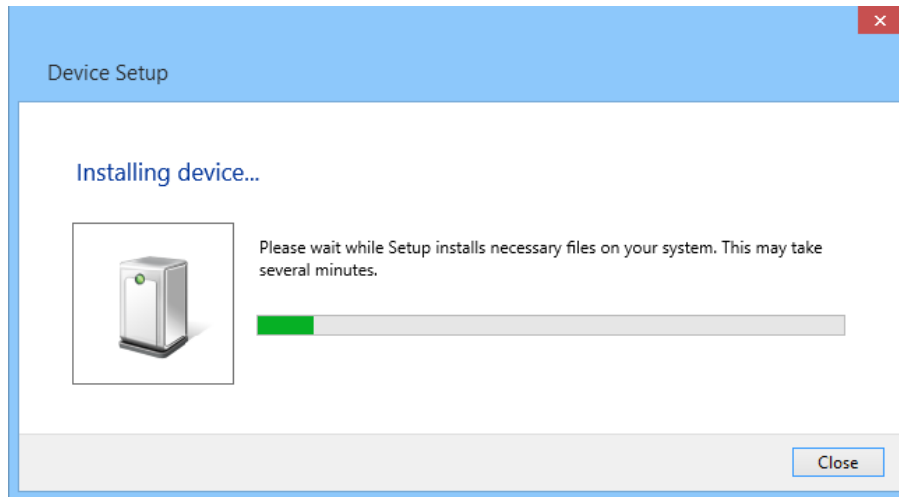

When the installation process ends, open the windows device manager and check the FDM-DUO USB serial port in the node Ports (COM & LPT).

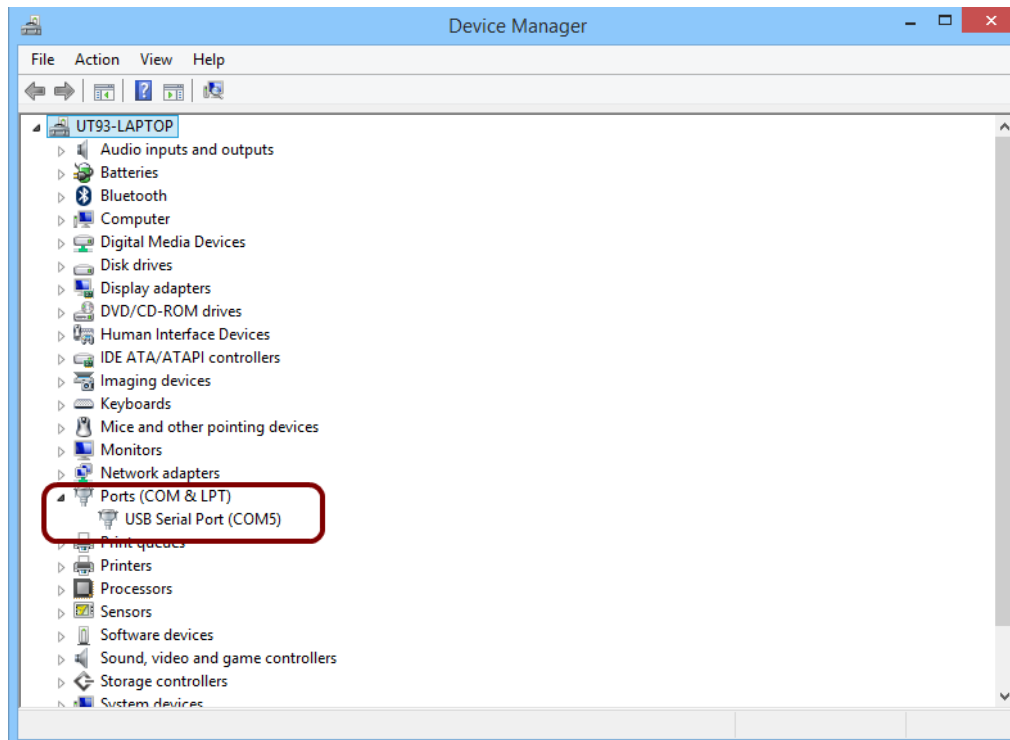

8 Firmware update

This section was removed from this manual. Please download the specific documentation about firmware update here: <http://sdr.eladit.com/FDM-DUO/>.

9 Technical Specifications

ELAD FDM-DUO TECHNICAL SPECIFICATIONS			Rev. 1 04/2015
GENERAL	USB 2.0 Ports (Peripheral Control)	3 (RX, TX, CAT)	
	Master Clock Frequency	122.88 MHz (Rx), 368.64 MHz (Tx)	
	Master Clock Phase Noise	-136 dBc @ 100 kHz, -130 dBc @ 10 kHz	
	10 MHz Reference Clock Stability	2.5 ppm TCXO within temperature range 0°C ÷ 40°C (32°F ÷ 104°F) Typical Stability within temperature range 15°C ÷ 35°C (59°F ÷ 95°F) 0.1 ppm i.e. 1Hz @ 10 MHz	
	Frequency Resolution	1 Hz min.	
	Antenna Connectors / Impedance	2x SO-239 / 50 Ohm	
	RF-OUT Connector / Impedance	SMA female / 50 Ohm	
	Power Supply Requirements	13.8 Vdc ± 10%	
	Current Drain (Rx / Tx 5 W)	<500 mA @ 13.8 V / <2.2 A @ 13.8 V	
	Dimensions (W x D x H)	180 mm (7.00") x 155 mm (6.10") x 70 mm (2.75") including knob and connectors 180 mm (7.00") x 130 mm (5.10") x 70 mm (2.75") enclosure only	
	Weight (approximate)	1.2 Kg (2.4 lb)	
Operating Temperature Range	0°C ÷ 40°C (32°F ÷ 104°F)		
Stand Alone Mode	RECEIVER		
	Modes	CW, USB, LSB, AM, FM	
	ADC Sampling Rate / Resolution	122.88 MHz @ 16 bits	
	Wideband Frequency Coverage	10 kHz ÷ 54 MHz	
	IQ Channel Bandwidth	192 kHz (24 bits)	
	Attenuator	12 dB	
	Spurious Response	>105 dBfs @ 0 dB attenuation	
	DDC Image Rejection Ratio	>100 dB	
	Receive Low Pass Filters Bandwidth	SSB: 300 Hz, 600 Hz, 1 kHz, 1.6 kHz ÷ 3.1 kHz (Step 100 Hz), 4 kHz, 5 kHz, 6 kHz AM: 2.5 kHz ÷ 6 kHz (Step 500 Hz) CW: 100 Hz & DR ⁽¹⁾ Level 1 ÷ 4, 100 Hz, 300 Hz, 500 Hz, 1kHz, 1.5 kHz, 2.6 kHz FM: Voice Narrow, Voice Wide, Data	
	Headphones Connector / Impedance	3.5 mm Stereo Jack / 8 Ohm	
	AUX OUT Connector / Impedance	3.5 mm Stereo Jack / 8 Ohm	
	TRANSMITTER		
	Modes	CW, USB, LSB, AM, FM	
	TX DAC Sampling Rate & Resolution	368.64 MHz @ 16 bits	
	RF Output Power	5 W Nominal, Adj. Steps: 0.3 W, 0.5 W, 1.0 W, 1.2 W, 1.5 W, 2.0 W, 3.0 W, 4.0 W, 5.0 W, MAX	
	Amateur Band Coverage at Rated Power Output	160 m ÷ 6 m	
	Low Pass PA Filter Bands	160 m ÷ 6 m Ham bands only	
	RF-OUT Output Power	-2 dBm Typical; 0 dBm Max	
	RF-OUT Frequency Coverage	100 kHz ÷ 165 MHz	
	Modulation System	IQ Digital	
	Maximum FM Deviation	5 kHz	
	Carrier Suppression / Unwanted Sideband Suppression	>80 dBc Typical / >80 dBc Typical	
	Harmonic Radiation 1.8 - 50 MHz Amateur Bands	>60 dBc	
	3 rd Order IMD	160 m ÷ 10 m: >30 dB @ 5 W PEP; 6 m: >25 @ 5 W PEP	
	Transmit Filters Bandwidth	SSB, AM: 300 Hz ÷ 2700 Hz Band Pass up to 50 Hz ÷ 4000 Hz Band Pass FM: 2500 Hz or 5000 Hz Low Pass	
	Microphone Connectors	RI45 ICOM Compatible	
Microphone Impedance	600 Ohm Nominal (200 ÷ 10 kOhm)		
PTT-OUT Connector	3.5 mm Stereo Jack, NPN Open Collector Output 20 V Max / 200 mA		
KEY-PAD Connector	3.5 mm Stereo Jack		
PC Based Mode (ELAD FDM-SW2 Software)	RECEIVER		
	Modes	CW, CW SH+, CW SH-, CW Narrow Band, USB, LSB, AM, FM, WB FM (Stereo + RDS), SYNC AM, DSB, RTTY, ECSS, DRM	
	IQ DDC Sampling Rate / Resolution	1 Channel (Slice) @ 32 bits: 192 kHz, 384 kHz, 768 kHz, 1536 kHz, 3072 kHz 1 Channel (Slice) @ 16 bits: 6144 kHz 2 Channels (Slices) @ 32 bits: 192 kHz, 384 kHz	
	Simultaneous Receivers	4 with 1 Channel (Slice) DDC, 8 with 2 Channels (Slices) DDC	
	Software Defined Filters	Double IF Notch Filters, Continuous Variable Band Filter	
	Advanced DSP Features	Noise Blanker, Adaptive Noise Reducer, Adaptive Auto Notch, AGC	
	Main Software Features	Recording and playback of IF and audio data stream, EIBI database support, Dx-Cluster spot visualization (Internet connection required), built in CAT protocol and Omni-Rig Server, double output channel (for VAC), support for external down-converter, WoodBox Tmate and Tmate2 compatibility	
	Software Visualization	Input Data (Spectrum + Waterfall), IF Data (Spectrum + Waterfall), Audio Data (Spectrum + Waterfall)	
	TRANSMITTER		
	Modes	CW, USB, LSB, AM, FM, IQ	
	Transmit Bandwidth	CW, USB, LSB, AM: default 300 ÷ 2700 Hz, up to 50 ÷ 4000 Hz FM: 2500 or 5000 Hz Low Pass	
	Advanced DSP Features	Equalizer, VOX, Audio Compressor, Overshoot Control (CESSB Algorithm), Level Limiter	
	Main Software Features	Playback of audio files (up to 4 presets)	
	Software Visualization	Waveform Monitor (Input Audio, Equalizer Output, Compressor Output, Filter Output, Overshoot Controller Output, Modulator Output, Limiter Output)	

(1) Digital Resonator

All stated specifications and other product information provided in this document are subject to change without notice or obligation.

Product Warranty

ELAD S.r.l. warrants the FDM-DUO for a period of 2 years inside Europe, and for a period of 1 year outside Europe unless otherwise specified. Warranty begins from the purchase date. All FDM-DUO will be repaired or replaced due to malfunction resulting from no fault of the end user. This warranty covers normal intended usage of the product and does not cover misuse, abuse, accidents, viruses, unauthorized service parts or the combination of other unauthorized branded products used in conjunction with the FDM-DUO.

Declaration of Conformity (EC)

The product marked as

FDM-DUO

manufactured by

Manufacturer: ELAD S.r.l.
Address: Via Col De Rust, 11 - Sarone
33070 CANEVA (PN)

is produced in conformity to the requirements contained in the following EC directives:

- R&TTE Directive 1999/5/CE
- EMC Directive 2004/108/CE
- Low Voltage Directive 2006/95/CE
- RoHS Directive 2011/65/CE

The product conforms to the following Product Specifications:

Emissions & Immunity:

ETSI EN 301 489-1 V1.9.2
ETSI EN 301 489-15 V1.2.1
ETSI EN 301 783-2 V1.2.1

Safety:

EN 60950-1:2006 + A11:2009 + A1:2010 + A12:2011 + A2:2013

And further amendments.

This declaration is under responsibility of the manufacturer:

ELAD S.r.l.
Via Col De Rust, 11 - Sarone
33070 CANEVA (PN)

Issued by:

Name: Franco Milan
Function: President of ELAD

Caneva
Place

July, 30th 2014
Date

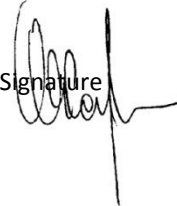
Signature 

Declaration of Conformity (FCC)

The product marked as

FDM-DUO

manufactured by

Manufacturer: ELAD S.r.l.
Address: Via Col De Rust, 11 - Sarone
33070 CANEVA (PN)

complies with the following requirements:

- FCC (Federal Communications Commission) Part 15

Operation is subject to the following two conditions:

- (1) This device may not cause harmful interference, and
- (2) This device must accept any interference received, including interference that may cause undesired operation.

NOTE: This equipment has been tested and found to comply with the limits for a Class B digital device, pursuant to Part 15 of the FCC Rules. These limits are designed to provide reasonable protection against harmful interference in a residential installation. This equipment generates, uses and can radiate radio frequency energy and, if not installed and used in accordance with the instructions, may cause harmful interference to radio communications. However, there is no guarantee that interference will not occur in a particular installation. If this equipment does cause harmful interference to radio or television reception, which can be determined by turning the equipment off and on, the user is encouraged to try to correct the interference by one or more of the following measures:

- Reorient or relocate the receiving antenna.
- Increase the separation between the equipment and receiver.
- Connect the equipment into an outlet on a circuit different from that to which the receiver is connected.
- Consult the dealer or an experienced radio/TV technician for help.

Changes or modification not expressly approved by the party responsible for compliance could void the user's authority to operate the equipment.

FCC ID: 2AAE5FDM-DUO

This product is distributed in USA by:

ELAD USA Inc.
7074 N RIDGE BLVD APT 3E
CHICAGO , IL 606453586
USA

Pho: 312-320-8160